



SOLAR BOOST™ 3024iL

30AMP 24VDC / 40AMP 12VDC MAXIMUM POWER POINT TRACKING PHOTOVOLTAIC CHARGE CONTROLLER

INSTALLATION AND OPERATION MANUAL



CONFORMS TO
UL STD. 1741
CERTIFIED TO
CAN/CSA STD. E335-1/2E



CONFORMS TO
EN 61326-1:2006
EN 60335-1:2002 + A11:2004 + A1:2004
EN 60335-2-29:2004

This device complies with part 15 of the FCC rules. Operation is subject to the following two conditions: 1) This device may not cause harmful interference, and 2) This device must accept any interference received, including interference that may cause undesired operations.



**THIS MANUAL INCLUDES IMPORTANT SAFETY INSTRUCTIONS FOR MODELS SB3024iL, SB3024DiL
SAVE THESE INSTRUCTIONS**

**CE MANUEL CONTIENT D'INSTRUCTIONS IMPORTANTES POUR LES MODELES SB3024iL, SB3024DiL
PRIERE DE SAUVEGARDER CES INSTRUCTIONS**

**DIESES HANDBUCH ENTHÄLT WICHTIGE HINWEISE FÜR DIE MODELLE SB3024iL, SB3024DiL
BITTE BEHALTEN SIE DIESE HINWEISE**

**ESTE MANUAL INCLUYE INSTRUCCIONES DE SEGURIDAD IMPORTANTES PARA LOS MODELOS SB3024iL, SB3024DiL
CONSERVE ESTAS INSTRUCCIONES**

COVERED UNDER ONE OR MORE OF THE FOLLOWING US PATENTS
6,111,391 • 6,204,645

TABLE OF CONTENTS

IMPORTANT SAFETY INSTRUCTIONS 2

PRODUCT DESCRIPTION..... 3

 Part Numbers and Options..... 3

OPERATION 3

 Charge Status Indicator..... 4

 Optional Digital Display 3

 Optional Remote Displays..... 3

 Multi-Stage Charge Control..... 3

 Bulk Charge 3

 Acceptance Charge..... 3

 Float Charge 4

 Equalization 4

 Automatic Equalization..... 4

 Manual Equalization..... 4

 Current Limit..... 4

 Temperature and Output Power..... 4

 Optional Temperature Compensation 5

 Maximum Setpoint Voltage Limit..... 5

 Maximum Power Point Tracking (MPPT) 5

 Multiple Charge Controllers On The IPN Network..... 5

INSTALLATION..... 5

 Electrostatic Handling Precautions..... 5

 Selecting PV Modules 6

 Solar Boost 3024i Setup..... 6

 As Shipped Factory Default Settings 6

 Restoring As Shipped Default Settings 6

 Battery And PV Voltage 7

 Charge Voltage, Float Voltage & Charge Time..... 7

 Output Current Display..... 8

 Battery and PV Wiring..... 8

 Electromagnetic Compatibility..... 8

 Battery Temperature Sensor..... 8

 Auxiliary Output..... 8

 Auxiliary Battery Charge 9

 Load Controller..... 9

 Dusk-to-Dawn Lighting Control 9

 Installing a Multi-Controller System..... 10

 Multi-Controller Wiring And Setup..... 10

 IPN Network..... 10

 Mounting..... 11

TROUBLESHOOTING GUIDE 12

SPECIFICATIONS..... 14

TWO YEAR LIMITED WARRANTY 15

TABLES AND FIGURES

 Table 1 Charge Status Indicator 3

 Table 2 Maximum Conductor Length - 3% Voltage Drop..... 8

 Figure 1 Front Panel and Remote Display Indicators..... 4

 Figure 2 Factory Charge Voltage Setpoint -vs.- Battery Temperature..... 5

 Figure 3 Setup and Wiring Diagram..... 7

 Figure 4 Auxiliary Output Wiring..... 9

 Figure 5 IPN Network Wiring..... 10

 Figure 6 Detailed Dimensional Drawing..... 11

Versión en Español..... 16



Version en Française..... 32

Deutsch Sprachversion..... 48

IMPORTANT SAFETY INSTRUCTIONS

This manual contains important instructions for Models SB3024iL and SB3024DiL
SAVE THESE INSTRUCTIONS

1. Refer installation and servicing to qualified service personnel. No user serviceable parts in this unit.
2. To reduce the risk of electric shock, fire or personal injury, the following symbols are placed throughout this manual to indicate dangerous conditions, or important safety or operational instructions.

WARNING	CAUTION	IMPORTANT
		
Indicates dangerous conditions or electric shock potential. Use extreme caution.	Indicates items critical to safe installation or operation of the unit.	Follow these instructions closely for proper operation of the unit

3. PERSONAL PRECAUTIONS

- a) Working in the vicinity of lead-acid batteries is dangerous. Batteries produce explosive gasses during normal operation.
- b) To reduce risk of battery explosion, follow these instructions and those published by battery manufacturer and manufacturer of any equipment you intend to use in vicinity of battery.
- c) Someone should be within range of your voice or close enough to come to your aid when you work near a lead-acid battery.
- d) Have plenty of fresh water and soap nearby in case battery acid contacts skin, clothing or eyes.
- e) Wear complete eye protection and clothing protection. Avoid touching eyes while working near battery.
- f) If battery acid contacts skin or clothing, wash immediately with soap and water. If acid enters eye, immediately flood eye with running cold water for at least 10 minutes and get medical attention immediately.
- g) NEVER SMOKE or allow a spark or flame in vicinity of battery.
- h) Be extra cautious to reduce risk of dropping metal tool onto battery. It might spark or short circuit battery or other electrical part that may cause explosion.
- i) Remove personal metal items such as rings, bracelets and watches when working with a lead-acid battery. A lead-acid battery can produce a short circuit current high enough to weld a ring or the like to metal, causing a severe burn.
- j) Remove all sources of power, photovoltaic and battery before servicing or installing.

4. CHARGER LOCATION & INSTALLATION

- a) This unit is designed to charge 12V (6-cell) or 24V (12-cell) flooded or sealed type lead-acid chemistry batteries within the range of 20 to 10,000 amp-hours. Follow battery manufacturers charging recommendations when considering this unit for use with other battery chemistry.
- b) This unit employs components that tend to produce arcs or sparks. NEVER install in battery compartment or in the presence of explosive gases.
- c) This unit must be installed and wired in accordance with National Electrical Code, ANSI/NFPA 70.
- d) Over current protection for the battery must be provided externally. To reduce the risk of fire, connect to a circuit provided with 50A maximum branch-circuit over current protection in accordance with National Electrical Code, ANSI/NFPA 70.
- e) Over current protection for the auxiliary load control output or auxiliary battery charge output must be provided externally. To reduce the risk of fire, connect to load or auxiliary battery with 25A maximum over current protection in accordance with National Electrical Code, ANSI/NFPA 70.
- f) Insure that unit is properly configured for the battery being charged.
- g) Unit is not water tight. Do not expose to rain or snow.
- h) Insure all terminating connections are clean and tight. Battery and PV compression terminals are to be tightened to 45 in-lb (5 nm). IPN Network and battery temperature sensor compression terminals are to be tightened to 2.1 in-lb (0.24 nm). Auxiliary output compression terminals are to be tightened to 6 in-lb (0.67 nm).
- i) Do not connect to a PV array capable of producing greater than 32A short circuit current for 12V nominal PV modules, or 24A short circuit for PV modules greater than 12V nominal. Limit input short circuit current to 12A if the 24V input 12V output mode is used.
- j) This unit is not provided with a GFDI (ground-fault detector/interrupter) device and must be used with an external GFDI device as required by Article 690 of National Electrical Code for the installation location.

5. PREPARING TO CHARGE

- a) Never charge a frozen battery.
- b) Be sure battery is mounted in a well ventilated compartment.
- c) Add distilled water in each cell of a lead-acid battery until battery acid reaches level specified by battery manufacturer.

PRODUCT DESCRIPTION

Solar Boost™ 3024iL is multi-stage *Maximum Power Point Tracking* (MPPT) photovoltaic battery charge controller capable delivering up to 30A or 40A depending on PV modules and battery voltage. The auxiliary output can serve as either a 2A auxiliary battery charger, or as a 20A load controller with or without variable Dusk-to-Dawn lighting control. The 3024 includes an IPN Network interface which allows multiple charge controllers to communicate with each other and operate as a single charging machine.

PART NUMBERS AND OPTIONS

- SB3024iL..... Solar Boost 3024iL charge controller
- IPNPRO IPN-ProRemote display & battery monitor
- CS-500 500A/50mV current shunt
- 930-0022-20 Battery temperature sensor
- SB3024DiL..... Solar Boost 3024iL controller with volt/amp display
- IPNPRO-S..... IPN-ProRemote with required 500A/50mV current shunt
- IPNREM..... IPN-Remote display

OPERATION

Charge control and MPPT operation are fully automatic. At night when PV power production stops, the PV array is disconnected from the battery to prevent unwanted current drain. There is a 5 second turn-on delay, and a 45 second turn-off delay.



➤ The 3024 operates on battery power, not PV power. A battery must be connected with a minimum voltage of 9V for the unit to operate.

CHARGE STATUS INDICATOR

A charge status indicator is provided on the face of the 3024, and on the optional remote displays. If net battery charge current is greater than ≈ 3 to 5A per 100 amp-hours of battery capacity the charge status indicator can provide a rough indication of battery state of charge.

CHARGE STATUS INDICATOR

CHARGE STATUS INDICATOR	CHARGE MODE	APPROXIMATE CHARGE LEVEL
OFF	CHARGE OFF	_____
CONTINUOUSLY ON	BULK	<70% FULL
BLINKING • 1 SEC ON / 1 SEC OFF	ACCEPTANCE	70% - 95% FULL
BLINKING • 0.2 SEC ON / 1 SEC OFF	FLOAT	FULLY CHARGED
RAPID BLINKING • 0.2 SEC ON / 0.2 SEC OFF	EQUALIZE	_____

TABLE 1

OPTIONAL DIGITAL DISPLAY

The SB3024DiL includes a digital display of battery voltage and output charge current. The display alternates between voltage and current when charging. Current is displayed when the "AMPS" indicator is on and can be the *total* of all controllers on the IPN network (factory default), or the current of a *single* controller on the IPN network. An automatic night time dimming feature reduces display brightness when PV charge is OFF.

OPTIONAL REMOTE DISPLAYS

Two remote displays are available. The IPN-Remote has the same display functionality as the SB3024DiL. The full featured IPN-ProRemote provides setup capability and enhanced monitoring of charge controllers on the IPN network. It also provides a complete battery system monitor with various amp-hour counters and a highly accurate "fuel gage" type battery level indicator.

MULTI-STAGE CHARGE CONTROL

Bulk Charge

The 3024 will be in Bulk charge when battery voltage is below the Acceptance Charge Voltage setpoint. During Bulk the 3024 delivers as much charge current as possible to rapidly recharge the battery. Automatic current limit prevents output current from exceeding the 3024's maximum current rating.

Acceptance Charge

When the battery recovers sufficient charge for voltage to rise to the Acceptance Charge Voltage setpoint (factory set to 14.4/28.8V) current is reduced as necessary to control at the Acceptance Voltage. The 3024 remains in Acceptance until the battery is fully charged as determined by either;

1. The 3024 has remained in Acceptance for the Charge Time period (factory set to 2 hours).

- OR -

2. With the IPN-ProRemote display, net battery charge current while in Acceptance decreases to the Float Transition Current setting (factory set to 1.5A per 100 amp-hours of battery capacity).

Float Charge

Once the battery is fully charged a somewhat lower Float Voltage (factory set to 13.2/26.4V) is applied to maintain the battery in a fully charged state without excessive water loss.

FRONT PANEL AND REMOTE DISPLAY INDICATORS

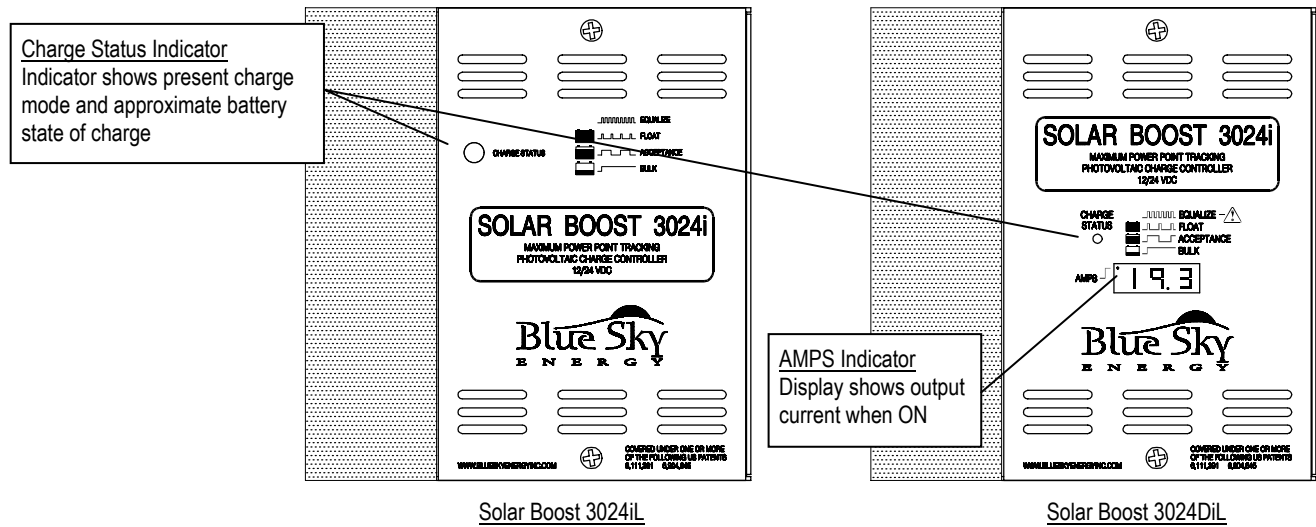

FIGURE 1

EQUALIZATION



➤ **WARNING:** Not all batteries can be safely equalized. Equalization should only be performed on vented liquid electrolyte lead-acid batteries. Always follow battery manufacturers recommendations pertaining to equalization. Equalization applies a high voltage producing significant battery gassing. Disconnect equipment that cannot tolerate the high equalization voltage which is temperature compensated.

Periodic equalization improves battery performance and life by bringing all battery cells up to the same specific gravity and eliminating electrolyte stratification. Equalization parameters are factory set to 15.2/30.4V for 2 hours every 30 days. A minimum net charge current of approximately 3A per 100 amp-hours of battery capacity is required for proper equalization. If insufficient current is available equalization may have to be canceled manually since the equalization time accumulator may not complete count down.

The equalization timer is a “time at voltage” time accumulator which counts in 3 minute increments. The equalization timer will not count down unless the battery is at the equalization voltage setpoint. Unless manually disabled the 3024 will stay in equalize for as long as necessary to accumulate the required time at voltage. If equalize does not complete by end of the charging day it will resume where it left off the next charging day.

Automatic Equalization

If DIP switch #5 is turned ON prior to the application of battery power, automatic equalization is enabled. The 3024 will perform automatic equalization after the set number of days has elapsed. (factory set to 30 days).

Manual Equalization

If DIP switch #5 is turned OFF, equalization is completely disabled. A manual equalize can be performed by turning DIP switch #5 ON, after battery power is applied. Following completion of a manually initiated equalization cycle, turn DIP switch #5 OFF. If DIP switch #5 remains ON automatic equalize is enabled. Equalization can also be controlled from the IPN-ProRemote if DIP switch #5 is ON.

CURRENT LIMIT

Automatic current limit prevents output current from exceeding 40A with 12V batteries and 12V PV's. If PV open circuit voltage (V_{oc}) ever exceeds 30V which would occur with PV voltage greater than 12V nominal, current limit will become 30A until the 3024 reboots. Note that when the 3024 exits current limit, it will briefly enter acceptance on it's way back to MPPT even though battery voltage may be low.

TEMPERATURE AND OUTPUT POWER

When mounted vertically as described in the installation section, the 3024 can deliver full output in an ambient temperature of up to 40°C (104°F). If an over temperature condition exists, the 3024 will cycle on/off, reducing average power delivery to within safe limits. During thermal shutdown the Charge Status Indicator will display an OFF condition.

OPTIONAL TEMPERATURE COMPENSATION

The optional battery temperature sensor automatically adjusts charge voltage setpoints based on battery temperature which enhances battery performance and life, and decreases maintenance. The default compensation factor of $-5.00\text{mV}/^\circ\text{C}/\text{cell}$ is suitable for most lead-acid chemistry batteries.

FACTORY DEFAULT CHARGE VOLTAGE SETPOINT -VS.- BATTERY TEMPERATURE

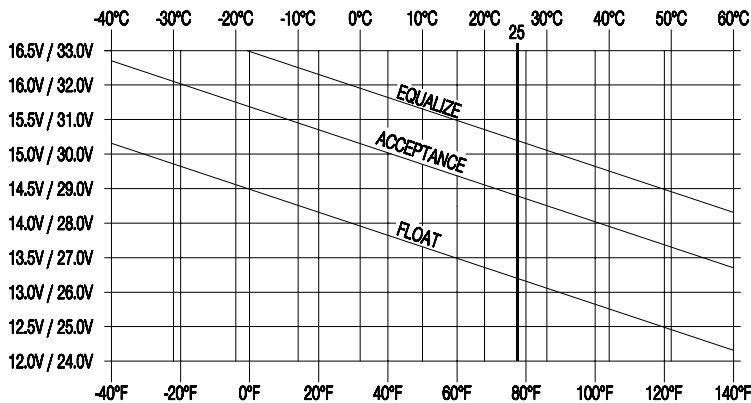

FIGURE 2

MAXIMUM SETPOINT VOLTAGE LIMIT

Regardless of setpoint values entered by the user or result from temperature compensation the 3024 will not apply a charge voltage setpoint greater than the maximum voltage setpoint limit factory configured to 15.5/31.0V. Note that actual battery voltage may briefly exceed this value by 0.1 – 0.2V as the voltage control servo responds to changes in load.

MAXIMUM POWER POINT TRACKING (MPPT)

Patented MPPT technology can extract more power and increase charge current up to 30% or more compared to conventional controllers. The principal operating conditions which affect current boost performance are PV array temperature and battery voltage. At constant solar intensity, available PV voltage and power *increase* as PV temperature *decreases* but it takes an MPPT controller to access this extra power. When PV voltage is sufficiently high in Bulk for MPPT to operate, a *constant power* output is delivered to the battery. Since output power is constant a *decrease* in battery voltage produces a further *increase* in charge current. This means that the 3024 provides the greatest charge current increase when you need it most, in cold weather with a discharged battery. In cool comfortable temperatures most systems see about 10 – 20% increase. Charge current increase can go to zero in hot temperatures, whereas charge current increase can easily exceed 30% with a discharged battery and freezing temperatures. For a more complete MPPT description see www.blueskyenergyinc.com.

MULTIPLE CHARGE CONTROLLERS ON THE IPN NETWORK

The IPN network architecture allows multiple charge controllers operate as a single charging machine. Up to 8 IPN compatible charge controllers can reside on a single network and can share a single display or battery temperature sensor. Charge controllers can be added to grow a small system into a large system and have this large system operate from the users standpoint as a single charge controller.

INSTALLATION



➤ **WARNING:** Read, understand and follow the Important Safety Instructions in the beginning of this manual before proceeding. This unit must be installed and wired in accordance with National Electrical Code, ANSI/NFPA 70. Over current protection must be provided externally. To reduce the risk of fire, connect to a circuit provided with 40A maximum branch-circuit over current protection (50A with 12V battery and 12V PV modules) in accordance with National Electrical Code, ANSI/NFPA 70. Do not connect a PV array capable of delivering greater than 24A of short circuit current I_{sc} at STC (32A with 12V battery and 12V PV modules). Do not connect BAT- and PV- together external to the unit. The unit is not provided with a GFDI (ground-fault detector/interrupter) device and must be used with an external GFDI device as required by Article 690 of NEC for the installation location. To reduce risk of electric shock, remove all sources of power before installing or servicing. Figures 3, 4 and 5 show generalized connections only and are not intended to show all wiring, circuit protection and safety requirements for a photovoltaic electrical system.



➤ **CAUTION:** The 3024 is protected against reverse battery and PV polarity, and swapped PV and battery connections, but will be damaged by reverse battery to the PV terminals. Transient voltage lightning protection is provided, but steady state voltage in excess of 57VDC on the battery or PV terminals will damage the unit. Damage of either type voids the limited warranty.

ELECTROSTATIC HANDLING PRECAUTIONS

To minimize the likelihood of damage, discharge yourself by touching a water faucet or other electrical ground prior to handling the 3024 and avoid touching circuit board components. The risk of electrostatic damage is highest when relative humidity is below 40%.

SELECTING PV MODULES

Voltage, current and power produced by Photovoltaic (PV) modules fluctuate widely with operating conditions. As a result a set of test conditions referred to as **Standard Test Conditions (STC)** are used to rate modules in a meaningful manner and accurately predict real world performance. STC ratings are not maximum or optimal ratings. Conditions can be present where V_{OC} and I_{SC} approach 1.25 times STC ratings which is why National Electrical Code and our recommendations call for 1.25 derating of both V_{OC} and I_{SC} . Yet in real world conditions I_{MP} is commonly only about 75 – 80% of I_{MP} at STC.

Key PV module specifications:

- P_{MAX} Maximum power in watts ($P_{MAX} = V_{MP} \times I_{MP}$)
- V_{OC} Voltage with module open circuit (typically $\approx 20 - 22V$ for 12V modules)
- V_{MP} Voltage where module produces Maximum Power (typically $\approx 17 - 18V$ for 12V modules)
- I_{MP} Current where module produces Maximum Power
- I_{SC} Current with module Short Circuit

The 3024 will provide the best MPPT current boost performance if all PV modules are identical. If module types are mixed, do not put dissimilar modules in series. Dissimilar modules in parallel should have V_{MP} values within $\approx 0.5V$ or better for 12V modules, and be of the same basic cell technology so their V_{MP} will tend to track as operating conditions change. If module types are very different consider using a separate charge controller for each module type to obtain the best MPPT current boost performance.

Select PV modules that do not exceed the maximum ratings shown below, and preferably produce at least 3A of I_{MP} per 100 amp-hours of battery capacity.

Nominal Battery Voltage	Automatic Current Limit	Maximum PV Power @ STC	Maximum PV I_{SC} @ STC	Maximum PV V_{OC} @ STC	Recommended range of V_{MP} at STC		
					Nominal 12V PV	Nominal 18V PV	Nominal 24V PV
12V	40A*	540W	32A*	24.0V*	16.5 – 18.5V	5	5
12V	30A	400W	16A	45.6V	5	24.8 – 27.8V	5
12V	30A	400W	12A	45.6V	5	5	33.0 – 37.0V
24V	30A	800W	24A	45.6V	5	5	33.0 – 37.0V

*Current rating and current limit are 40A when charging a 12V battery from nominal 12V PV modules. If PV V_{OC} ever exceeds 30V (>12V nominal PV modules) current rating and current limit become 30A.

SOLAR BOOST 3024 SETUP



➤ The 3024 has various setup parameters all of which are preconfigured at the factory. Confirm that the 3024's charge parameter settings are within the ranges specified by the battery manufacturer. Default settings are typically suitable for most flooded or sealed lead-acid batteries and likely require no changes.

➤ Setup parameters are divided into two categories, **Basic** and **Advanced**. Basic parameters can be configured with the 3024 alone within limited steps and ranges as shown in Figure 3. Advanced parameters require the IPN-ProRemote to access. The IPN-ProRemote also allows basic settings to be configured in smaller steps and over wider ranges. All setup parameters are retained if power is lost, or the IPN-ProRemote is used as a setup tool only and removed.

As Shipped Factory Default Settings

Basic Settings

- Charge mode 3-stage
- Acceptance voltage 14.4/28.8V
- Float voltage 13.2/26.4V
- Charge time 2.0 hours
- Equalize Disabled
- IPN Network address 0 (zero)
- Auxiliary Output mode Aux. bat. charger
- All DIP switches OFF
- Current display (SB3024Di)..... IPN network total

Advanced Settings

- Equalize voltage 15.2/30.4V
- Equalize time 2.0 hours
- Auto equalize days 30 days
- Maximum voltage setpoint limit 15.5/31.0V
- Float Transition Current 1.5A/100 amp-hours
- Temperature compensation factor -5.00mV/°C/cell
- Load control ON voltage 12.6/25.2V
- Load control OFF voltage 11.5/23.0V
- Dusk-to-Dawn lighting control Disabled

Restoring As Shipped Factory Default Settings

1. Remove PV and battery power.
2. Turn ALL 8 power board DIP switches shown in Figure 3 ON.
3. Restore battery power for 10 seconds, then remove battery power.
4. Return ALL 8 power board DIP switches to their default OFF position.
5. If display is present, set display DIP's to #4 ON, #1-3 OFF
6. The unit is now set to as shipped factory default settings.

Battery and PV Voltage



➤ Nominal battery and PV voltage are determined automatically. The battery is considered to be 12V if battery voltage when first connected is less than 16V, or 24V if battery voltage is greater. PV voltage is also determined automatically. If nominal PV voltage is changed following installation power must be momentarily removed to reboot the 3024.

Charge Voltage, Float Voltage & Charge Time

Acceptance Charge Voltage, Float Charge Voltage and Charge Time setpoints can be viewed or changed using the parameter setup LED's and DIP switch shown in Figure 3. Operate only one switch at a time. To view the present setting turn the appropriate DIP switch ON momentarily (V_{CHG} #8, V_{FLOT} #6 or T_{CHG} #7). For a 24V battery the actual voltage setpoints are doubled.

To change a setting, turn the appropriate DIP switch ON, OFF, and then back ON before the LED's turn OFF. The 3024 will enter setup mode and scan through available settings. Turn the DIP switch off at the desired setting to store the new value. If Float Charge Voltage is set to "No Float" the 3024 operates as a two stage charger, will not switch to Float, and will not display Charge Time on the setup LED's.

SETUP AND WIRING DIAGRAM

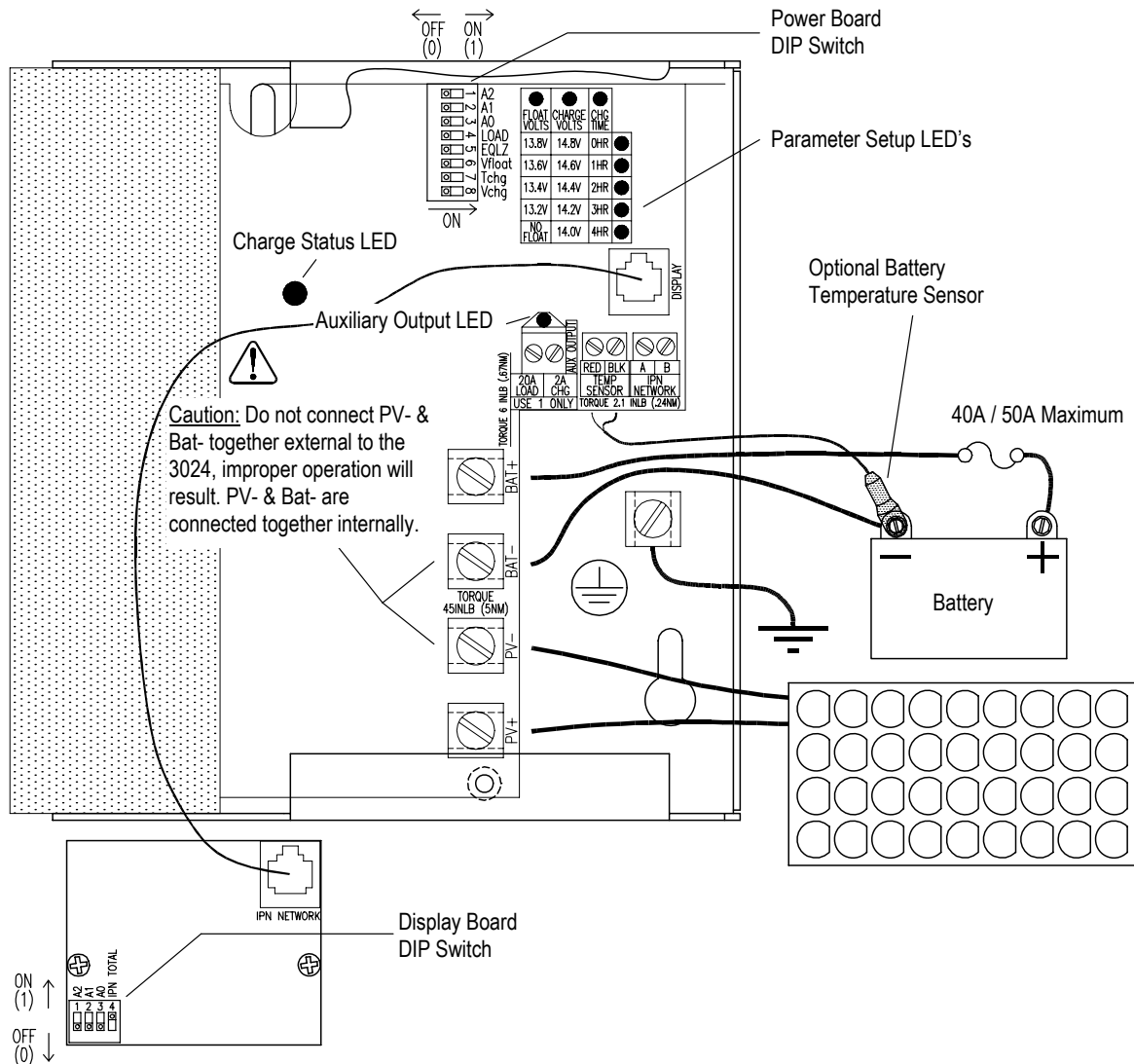

FIGURE 3

Output Current Display (SB3024DiL only)



➤ The display can show total output current from all networked controllers, or the output current of a single controller. To show output current from a single controller IPN network address of the display and charge controller must match.

DISPLAY BOARD DIP SWITCH	IPN ADDRESS – OUTPUT CURRENT OF SINGLE CHARGER UNIT								TOTAL OUTPUT CURRENT OF ALL CHARGERS ON IPN NETWORK
	0	1	2	3	4	5	6	7	
# 1 (A2)	OFF	OFF	OFF	OFF	ON	ON	ON	ON	Don't care
# 2 (A1)	OFF	OFF	ON	ON	OFF	OFF	ON	ON	Don't care
# 3 (A0)	OFF	ON	OFF	ON	OFF	ON	OFF	ON	Don't care
# 4 (IPN Total)	OFF	OFF	OFF	OFF	OFF	OFF	OFF	OFF	ON

BATTERY AND PV WIRING



➤ **CAUTION:** Battery and PV compression terminals accept #14–4 AWG wire and are tightened to 45 in-lb (5 nm). IPN network compression terminals accept #24–14 AWG wire and are tightened to 2.1 in-lb (0.24 nm). Auxiliary Output compression terminals accept #24–12 AWG wire and are tightened to 6 in-lb (0.67 nm).

➤ **CAUTION:** DO NOT connect Bat– and PV– together external to the 3024 or improper operation will result. Bat– and PV– connect together internally.

A desirable installation would produce a total system wiring voltage drop of 3% or less. The lengths shown in Table 2 are one way from the PV to the battery with the 3024 located along the path. Wire length can be increased inversely proportional to actual current. If current was reduced by ½, wire lengths could doubled and still provide 3% voltage drop.

MAXIMUM CONDUCTOR PAIR LENGTH - 3% VOLTAGE DROP

WIRE GAUGE AWG	12 VOLT SYSTEM @32A FEET / METERS	24 VOLT SYSTEM @24A FEET / METERS
12 AWG	4.0 / 1.2	10.7 / 3.3
10 AWG	6.4 / 2.0	16.9 / 5.2
8 AWG	10.1 / 3.1	26.9 / 8.2
6 AWG	16.1 / 4.9	42.8 / 13.0
4 AWG	25.5 / 7.8	68.1 / 20.7
2 AWG	40.6 / 12.4	108.2 / 33.0
1/0 AWG	64.6 / 19.7	172.2 / 52.5

TABLE 2

ELECTROMAGNETIC COMPATIBILITY

To comply with electromagnetic compatibility requirements the 3024's battery and PV wiring must be installed in grounded metallic conduit, and the two clamp on type ferrite suppressors supplied must be installed. Clamp one suppressor around both Bat+ and Bat– cables. Clamp the second suppressor around both the battery temperature sensor and remote display cables with the cables looped to pass through the core 3 times. If both sensor and display cables are used, the sensor cable outer cover must be stripped back ≈12" (30cm) so both cables will fit through the core 3 times. Ensure that the two suppressors are restrained so they will not damage circuit board components. Additional suppressors can be ordered as BSE p/n 523-0005-01.

BATTERY TEMPERATURE SENSOR

Installation of the optional battery temperature sensor enables temperature compensation of all charge voltage setpoints. In a multi-controller system a single temperature sensor must connect to the IPN master. Do not attach a sensor or connections other than Blue Sky Energy battery temperature sensor p/n 930-0022-20. Be certain to observe proper RED/BLK polarity.

AUXILIARY OUTPUT

The auxiliary output can serve one of three functions; a 2A auxiliary battery charger, a 20A load controller with Low Voltage Disconnect (LVD), or a 20A variable Dusk-to-Dawn lighting load controller. The Charge/Load function is selected by DIP switch #4 shown in Figure 3. The IPN-ProRemote is required to adjust LVD thresholds or enable Dusk-to-Dawn lighting control. Auxiliary outputs in a multi-controller system will function normally, but only the auxiliary output in the master can be configured or monitored using the IPN-ProRemote. The auxiliary output "Load" LED will illuminate whenever the auxiliary output is ON.



➤ **CAUTION:** The auxiliary output cannot perform both auxiliary battery charge and load control functions at the same time. Do not connect to the 20A Load terminal for auxiliary battery charge.

AUXILIARY BATTERY CHARGE – DIP #4 OFF

The auxiliary charge function is used to charge an auxiliary battery of the same voltage as the primary battery. If the primary battery is charging in Acceptance or Float, up to 2A is diverted to the auxiliary battery at roughly the same charge voltage. Auxiliary battery charge is disabled during bulk or equalization. Use 14awg wire to minimize voltage drop and 25A over current protection. Auxiliary battery negative must connect to primary battery negative.

AUXILIARY OUTPUT WIRING

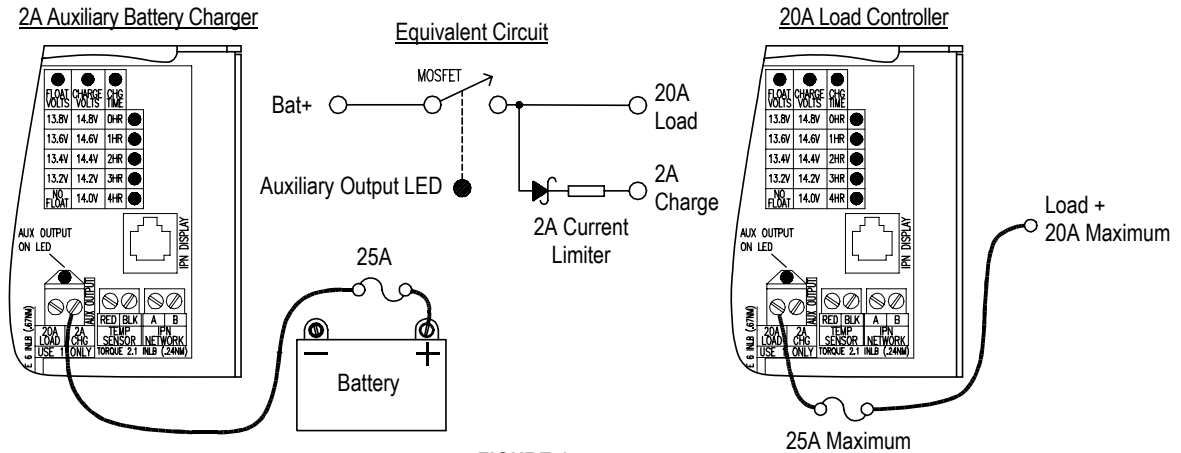

FIGURE 4

LOAD CONTROLLER – DIP #4 ON

The load controller can deliver up to 20A of continuous output from the battery. Default settings are for LVD operation with ON at $V_{BAT} \geq 12.6/25.2V$, and OFF at $V_{BAT} \leq 11.5/23.0V$, which can be changed using the IPN-ProRemote. Operation can also be based on net battery amp-hours if an IPN-ProRemote is present. The ON/OFF condition must be valid for 20 seconds before switching will occur. If the higher/lower values are reversed the output control logic is inverted. Load negative must connect to battery negative.



➤ **CAUTION:** 25A maximum over current protection for load control output must be provided externally. If the load control output is configured to operate based on net battery amp-hours, configure ON/OFF voltage thresholds as well. If amp-hour from full data is not available, voltage based operation will resume. Voltage or amp-hour ON/OFF thresholds must not be the same value or improper operation will result.

DUSK-TO-DAWN LIGHTING CONTROL – DIP #4 ON

An IPN-ProRemote with software version V2.00 or later is required to enable lighting control. Refer to IPN-ProRemote operators manual for lighting control setup instructions. Variable time settings are available to turn lighting ON after Dusk (Post-Dusk timer) and/or ON before Dawn (Pre-Dawn timer). If both timers are set to DISABLED (factory default), the lighting control feature is disabled. If either the Post-Dusk or Pre-Dawn timers are set to a time value the lighting control feature is enabled. When lighting control is enabled the auxiliary output is controlled by both the normal load control function and the lighting control function such that whichever function wants the auxiliary output OFF prevails.

Dusk or night time begins when the charge control system turns OFF which occurs when PV module current drops below $\approx 50mA$ at battery voltage. Dawn or day time begins when the charge control system turns ON which occurs when PV module current rises to $\approx 100mA$ at battery voltage. If the Post-Dusk timer was set to 1.0 hour and the Pre-Dawn timer was set to 2.0 hours, lights would turn ON at Dusk, remain ON for one hour, and then turn OFF. Two hours before Dawn the lights would again turn ON and remain ON until Dawn. For full Dusk to Dawn lighting set the Post-Dusk timer to 20 hours. Lights will always be OFF when the charge control system is ON.

When the 3024 first receives battery power it does not know when Dawn is expected to occur. As a result Pre-Dawn control does not operate for the first night. Once a night time period of 4 hours or more is detected this night time period is stored and Pre-Dawn control will operate. Each subsequent night time period greater 4 hours is added to a filtered average of night time.

INSTALLING A MULTI-CONTROLLER SYSTEM

A communication link is established between controllers by daisy chaining a twisted pair cable from the IPN Network terminal block, controller to controller (A-to-A, B-to-B) as shown in Figure 5. Up to 8 IPN based charge controllers can be connected together in a multi-controller system. Device address 0 (zero) is the master and 1 – 7 are slaves. The master controls the charging process and directs the activities of the slaves. The charge control system will start whenever one or more controllers receives PV input power.

MULTI-CONTROLLER WIRING AND SETUP



- **CAUTION:** A multi-controller system requires the following specialized installation and setup:
- 1) Each controller must connect to and charge the same battery.
 - 2) One controller must be set to IPN address 0 (zero) and the others be set to addresses 1 – 7 with no controllers set the same.
 - 3) Charge parameters are set in the master only.
 - 4) While outputs connect in parallel to a common battery, PV inputs must be completely separate. A large PV array must be divided into sub-arrays, each with separate PV+ and PV- wiring.
 - 5) All controllers must be connected to the IPN network as shown in Figure 5.

IPN NETWORK WIRING

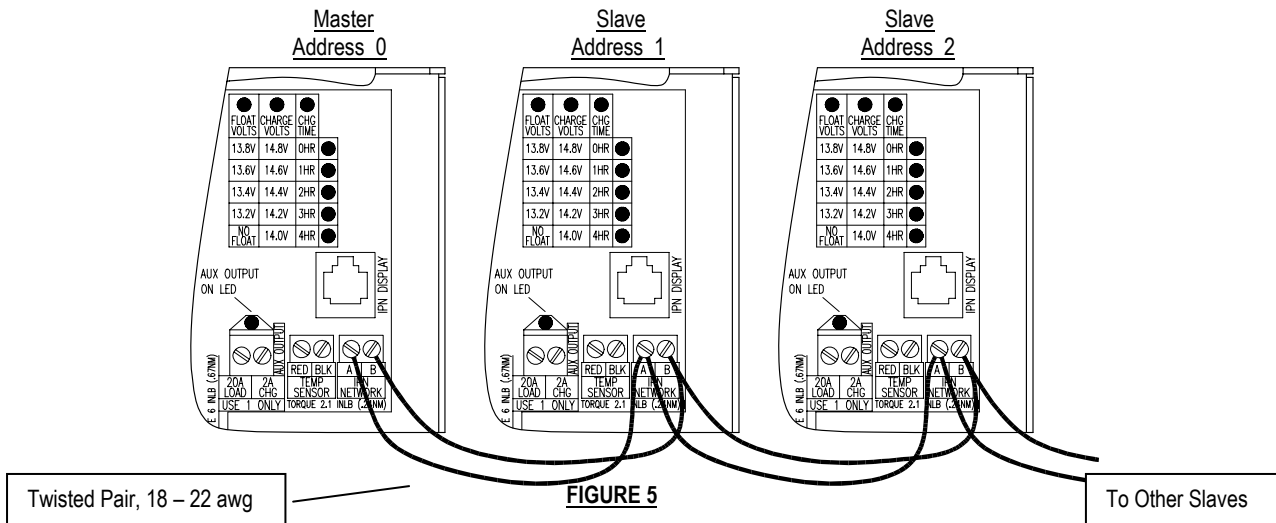

FIGURE 5

IPN Network Address



➤ A single controller must be set to IPN network address 0 (zero). In a multi-controller system one controller must be set to address 0 (zero) to serve as the master. The other controllers must be set to address 1-7 with no two controllers set the same.

POWER BOARD DIP SWITCH	IPN NETWORK ADDRESS							
	MASTER 0	1	2	3	4	5	6	7
# 1 (A2)	OFF	OFF	OFF	OFF	ON	ON	ON	ON
# 2 (A1)	OFF	OFF	ON	ON	OFF	OFF	ON	ON
# 3 (A0)	OFF	ON	OFF	ON	OFF	ON	OFF	ON

MOUNTING



➤ **CAUTION:** Mount the unit with heatsink fins oriented vertically to promote cooling and do not enclose in a confined space. The 3024 is not watertight and must be protected from rain, snow and excessive moisture.

DETAILED DIMENSIONAL DRAWING

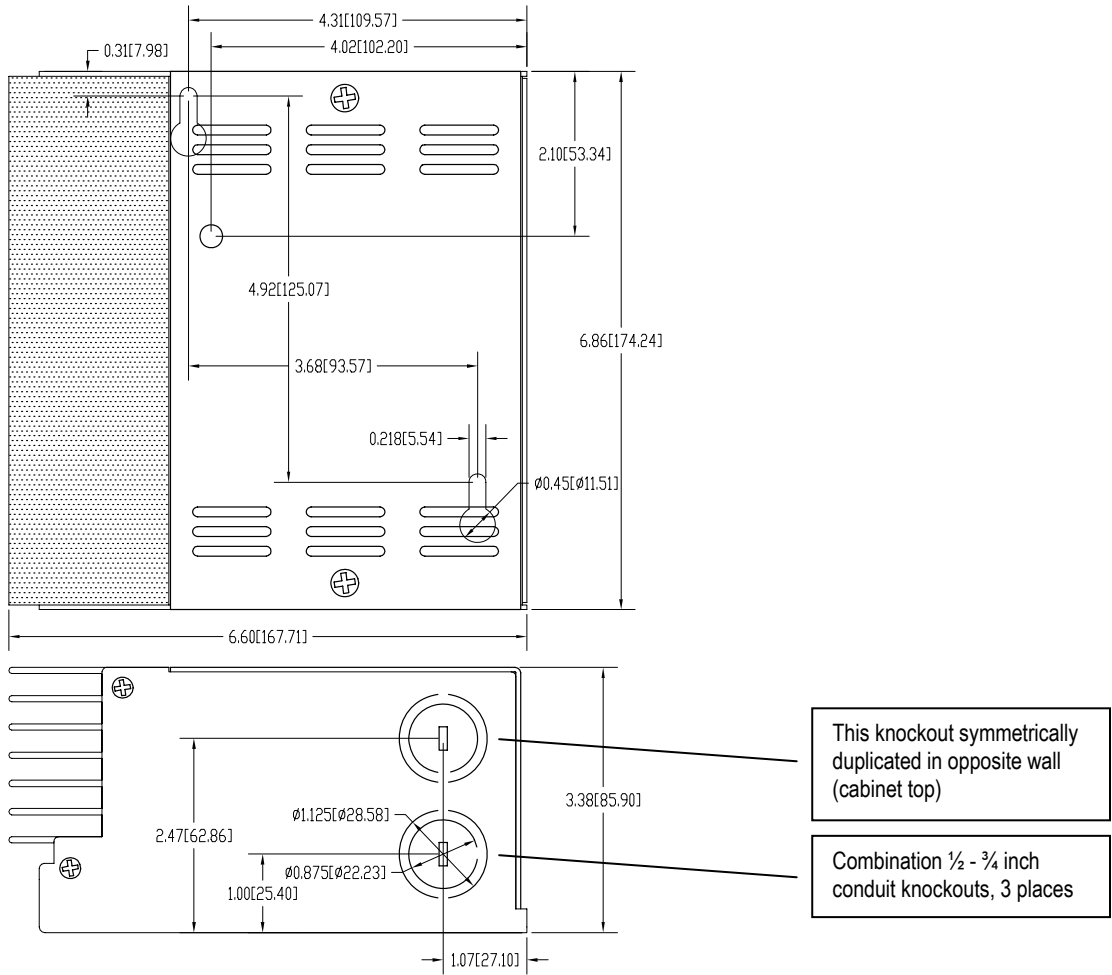

FIGURE 6

TROUBLESHOOTING GUIDE

SYMPTOM	PROBABLE CAUSE	ITEMS TO EXAMINE OR CORRECT
Completely dead, no display	No battery power	Battery disconnected, overly discharged (<9V), or connected reverse polarity. Battery powers unit, not PV.
Unit will not turn on (charge status LED off), Display if present may be OK	PV disconnected PV reverse polarity IPN network address set wrong Low battery power Extreme voltage fluctuations or interference has caused microprocessor lock-up	PV must supply at least 0.15A at just above battery voltage to begin charge. Reverse polarity PV will cause heat sink to heat. A single unit must be set to IPN network address 0 (zero). One unit of a multi-unit network must be set to IPN network address 0 (zero), AND all other units must be set to different addresses. Battery overly discharged (<9V). Battery powers unit, not PV. Reboot microprocessor by momentarily removing all power. Reattach power crisply.
Unit cycles on/off	PV- connected to BAT- external to unit	PV- & BAT- must be separate external to the unit for proper operation and cannot connect to a common location. External connection prevents proper operation of internal shunts and current measurement system.
Charge status LED on., but no output charge current	Battery voltage greater than charge voltage setpoint Battery voltage too low Unit recognized battery voltage to be 12V when it is actually 24V	This is normal operation. Output is off due to high battery voltage which may be caused by other charging systems. Battery voltage must be at least 9V for the unit to operate. Battery voltage is determined automatically when the unit first receives power. Voltage must be greater than 16V to recognize battery as 24V. Remove all power, and reapply battery quickly and crisply.
Charge status LED blinks rapidly	System in equalize mode	Disable equalize via IPN-ProRemote, or by turning DIP switch #5 off.
Charge current is lower than expected, PV current may be low as well	Battery is highly charged Worn out PV modules Low insolation PV- connected to BAT- Nominal PV voltage has changed from 18V or 24V to 12V Current limit has switched to 30A	Normal operation, current is reduced if battery voltage is at setpoint. Replace, or use as is. Atmospheric haze, PV's dirty, sun low on horizon, etc. PV- & BAT- must be separate external to the unit for proper operation and cannot connect to a common location. External connection prevents proper operation of internal shunts and current measurement system. If PV voltage is changed to 12V, all power must be removed momentarily to reboot unit and load initial PV control values. Normal operation. Current limit will change to 30A if PV V_{OC} has exceeded 30V which will occur with greater than 12V nominal PV's. Reconfigure PV's for 12V and reboot 3024 to resume 40A current limit.
MPPT Current boost is less than expected	PV maximum power voltage (V_{MP}) is not much higher than battery voltage, leaving little extra power to be extracted PV's hot Nominal PV voltage has changed from 18V or 24V to 12V	PV's with low V_{MP} . PV's with higher V_{MP} produce greater power and current boost potential. PV's with $V_{MP} \geq 17V$ work best. Excessive PV wiring voltage drop due to undersize wiring, poor connections etc. Battery is nearly charged and battery voltage is high. Output during MPPT operation is "constant power", higher battery voltage reduces charge current increase. V_{MP} and available power decrease with increasing PV cell temperature. Cooler PV's will produce greater boost. It is normal for boost to decrease as temperature rises. If PV voltage is changed from 12V, all power must be removed momentarily to reboot unit and load initial PV control values.
Auxiliary battery not charging	Auxiliary output not configured for auxiliary battery charge Primary battery not highly charged Load on Auxiliary battery too high	Confirm dip switch #4 is OFF. Auxiliary battery will not receive charge unless primary battery is highly charged in Acceptance or Float. Maximum auxiliary charge current is roughly 2A. Load may need to be reduced.

SYMPTOM	PROBABLE CAUSE	ITEMS TO EXAMINE OR CORRECT
System appears OK, but will not correctly switch between Bulk, Acceptance & Float	<p>Not set for 3 stage charge</p> <p>System will not switch out of Bulk and into Acceptance or Float</p> <p>System will not switch from Float to Bulk or Acceptance</p> <p>System will not switch from Acceptance to Float</p> <p>System shows Acceptance at times but battery voltage is low and current is very high near max. rating.</p>	<p>Check Float voltage setpoint.</p> <p>Battery is highly discharged or very large relative to available net charge current. PV power may be too low or loads too high.</p> <p>Normal operation. Unit will stay in Float and not switch to Bulk or Acceptance until it is unable to hold the battery at the Float voltage setpoint.</p> <p>Battery not fully charged. Unit will not switch to Float until battery voltage remains at the Acceptance voltage setpoint continuously for the Charge Time period (or net battery current drops to the Float Transition Current setpoint if using IPN-ProRemote).</p> <p>Normal operation. If the unit enters current limit, it will pass through Acceptance for about 10 seconds upon exiting current limit and returning to Bulk/MPPT.</p>
Load control not working properly	<p>Auxiliary output not set for load control</p> <p>Output may have shut off due to low battery charge</p> <p>ON/OFF thresholds set to inappropriate values</p> <p>Dusk-to-Dawn feature enabled</p>	<p>Confirm dip switch #4 is ON.</p> <p>Load will shut off if battery voltage drops below OFF threshold (default 11.5/23.0V). Once shut off, the load will turn on until battery voltage is above ON threshold (default 12.6/25.2V).</p> <p>Correct settings.</p> <p>Disable Dusk-to-Dawn control.</p>
Dusk-to-Dawn feature, lights will not turn ON or remain ON	<p>Auxiliary output not set for load control</p> <p>Output may have shut off due to low battery charge</p> <p>Charge control system ON</p> <p>Timers set incorrectly</p> <p>First valid night time not seen yet</p>	<p>Confirm dip switch #4 is ON and Dusk-to-Dawn enabled.</p> <p>Load will shut off if battery voltage drops below OFF threshold (default 11.5/23.0V). Once shut off, the load will not come back on until battery voltage is above ON threshold (default 12.6/25.2V).</p> <p>Lights will not turn on if charge control system is ON and charging.</p> <p>Check Post-Dusk and Pre-dawn timer settings</p> <p>Pre-Dawn lighting will not operate until a valid night time of greater than 2 hours is detected to initialize the night time period.</p>
Dusk-to-Dawn feature, lights will not turn OFF or remain OFF	<p>Auxiliary output not set for load control</p> <p>Dusk-to-Dawn feature not enabled.</p> <p>Timers set incorrectly</p> <p>Charge control does not turn ON</p>	<p>Confirm dip switch #4 is ON and Dusk-to-Dawn enabled.</p> <p>Post-Dusk and Pre-dawn timers both set to DISABLED. One or both timers must be set to enable Dusk-to-Dawn feature.</p> <p>Correct Post-Dusk and Pre-dawn timer settings.</p> <p>Check charge control operation</p>
Networked units do not seem to coordinate action or slaves do not turn on	<p>IPN network address set wrong</p> <p>Network wiring problem</p>	<p>A single unit must be set to IPN network address 0 (zero).</p> <p>One unit of a multi-unit network must be set to IPN network address 0 (zero), AND all other units must be set to different addresses.</p> <p>Confirm wiring. Use IPN-ProRemote to View Charge Unit Status and confirm communication.</p>
Temperature related functions do not work.	<p>Temperature sensor missing, failed or installed reverse polarity</p> <p>Temperature sensor not installed on master</p>	<p>If sensor is open, short, reverse polarity or missing unit will operate as if sensor was at 25°C. Sensor voltage when connected should be 2.98V at 25°C, changing at +10mV/°C.</p> <p>Temperature sensor must be installed on the master in a multi-controller system.</p>
Display turns on, but battery voltage displays “---” rather than a number	<p>Display not communicating with charge controller</p>	<p>Cable faulty</p> <p>One charge controller only must be Master.</p> <p>Poor or missing Bat – connections preventing communication</p>
When charger turns on, output current displays “---” rather than a number	<p>Output current display selection set for an address not present on the IPN network</p>	<p>Configure display IPN network address to a charger present on the IPN network.</p>

SYMPTOM	PROBABLE CAUSE	ITEMS TO EXAMINE OR CORRECT
Charge OFF at high ambient temperature	System temporarily shuts down due to high heat sink temperature	Improve ventilation or reduce PV power. Sufficient ventilation to prevent over temperature shut down will improve reliability. See Technical Bulletin #100206.
When charger turns on, output current displays but the value seems incorrect	Output current display selection set for wrong IPN network address Bat- connected to PV- outside charge controller	Configure display IPN network address DIP switch to read desired output current. PV- & BAT- must be separate external to the unit for proper operation and cannot connect to a common location. External connection prevents proper operation of internal shunts and current measurement system.
Voltage or current value displayed seems to be stuck and does not change	Display or charge controller IPN network addressed has changed Display not communicating with charge controller	Configure display IPN network address DIP switch to properly read output current of a charger present on the IPN network Intermittent display cable.

SPECIFICATIONS

SPECIFICATIONS	Solar Boost 3024iL & 3024DiL
Output Current Rating	30A / 40A ^{3†}
Nominal Battery Voltage	12 / 24VDC
PV Input Voltage	57VDC maximum
Power Consumption	Typical 0.35W standby • 1.0W Charge ON
Charge Algorithm	3-stage Bulk/Acceptance/Float • plus Equalize
Acceptance Voltage	14.4VDC [§] (range 14.0 – 14.8VDC [§] , 10.0 – 40.0VDC [‡])
Float Voltage	13.2VDC [§] (range 13.2 – 13.8VDC [§] , 10.0 – 40.0VDC [‡])
Equalization Voltage	15.2VDC [§] (range 10.0 – 40.0VDC [‡]) • automatic or manual
Voltage Setpoint Limit	15.5VDC [§] (range 10.0 – 40.0VDC [‡])
Auxiliary Output	Single output configurable as either: 20A load controller –or– 2A auxiliary battery charger
• Aux. Battery Charge	2A typical, same charge voltage as primary battery
• Load Control	20A maximum, ON ≥12.6VDC [§] / OFF ≤11.5VDC [§] (Range 10.0 – 40.0VDC [‡] , or net battery AH [‡])
• Dusk-to-Dawn Control [‡]	Variable Post-Dusk and Pre-Dawn timers [‡] , Range 0.5 – 20.0 hours
Temperature Compensation	Optional sensor adjusts charge voltage based on battery temperature –5.00 mV/°C/cell correction factor (Range 0.00 to –8.00 mV/°C/cell [‡]) • sensor range –60 to +80°C
Power Conversion Efficiency	97% typical @ 28V / 24A Output
Cabinet Dimensions	6 ³ / ₈ "H x 6 ³ / ₈ "W x 3 ³ / ₈ "D (17.4cm x 16.8cm x 8.59cm)
Volt/Amp Accuracy/Range	Battery voltmeters 40.0VDC±0.50% FS • PV voltmeter 60.0VDC±0.50% FS Ammeters 41.0A±0.50% FS
Communication	Blue Sky Energy's proprietary IPN Network interface
Environmental	–40 to +40°C, 10 – 90% RH non-condensing

As a part of our continuous improvement process specifications are subject to change without prior notice

[§] SB3024i alone, voltages double for 24V battery

[‡] With IPN-ProRemote

[†] 40A with 12V battery and 12V PV modules

FIVE YEAR LIMITED WARRANTY

Blue Sky Energy, Inc. (hereinafter BSE), hereby warrants to the original consumer purchaser, that the product or any part thereof shall be free from defects due to defective workmanship or materials for a period of five (5) years subject to the conditions set forth below.

1. This limited warranty is extended to the original consumer purchaser of the product, and is not extended to any other party.
2. The limited warranty period commences on the date the product is sold to the original consumer purchaser. A copy of the original purchase receipt identifying purchaser and date of purchase, must accompany the product to obtain warranty repairs.
3. This limited warranty does not apply to, and future warranty shall become void, for any product or part thereof damaged by; a) alteration, disassembly or application of a foreign substance, b) repair or service not rendered by a BSE authorized repair facility, c) accident or abuse, d) corrosion, e) lightning or other act of God, f) operation or installation contrary to instructions pertaining to the product, or g) cosmetic aging.
4. If BSE's examination of the product determines that the product is not defective the consumer shall be charged a test and evaluation fee of \$40 and be responsible for all transportation costs and insurance related to returning the product to the consumer. The consumer is ultimately responsible for proper installation and operation of the product and BSE's prior troubleshooting assistance shall not serve as a waiver of the test and evaluation fee. The test and evaluation fee is subject to change without prior notice.
5. If within the coverage of this limited warranty, BSE shall repair or replace the product at BSE's sole discretion and return the product via standard ground transportation of BSE's choosing within the continental US. The consumer shall be responsible for all transportation costs and insurance to return the product outside the continental US, and for all transportation costs and insurance related to expedited return of the product. BSE's liability for any defective product or any part thereof shall be limited to the repair or replacement of the product. BSE shall not be liable for any loss or damage to person or property, or any other damages, whether incidental, consequential or otherwise, caused by any defect in the product or any part thereof.
6. Any implied warranty for merchantability or fitness for a particular purpose is limited in duration to the length of this warranty.
7. To obtain warranty repairs, contact BSE at 760-597-1642 to obtain a Returned Goods Authorization (RGA) number. Mark the outside of the package with the RGA number and return the product, postage prepaid and insured to the address below. The consumer is responsible for all transportation costs and insurance related to returning the product to BSE, and for any shipping damage which may void the warranty or increase the cost of repairs.

**Blue Sky Energy, Inc.
2598 Fortune Way, Suite K
Vista, CA, 92081, USA**

800-493-7877 • 760-597-1642 • Fax 760-597-1731 • www.blueskyenergyinc.com