

# 2014 F-Series Super Duty Class A Motorhome and Commercial Chassis Owner's Manual



fordowner.com



ford.ca



The information contained in this publication was correct at the time of going to print. In the interest of continuous development, we reserve the right to change specifications, design or equipment at any time without notice or obligation. No part of this publication may be reproduced, transmitted, stored in a retrieval system or translated into any language in any form by any means without our written permission. Errors and omissions excepted.

© Ford Motor Company 2014

All rights reserved.

Part Number: 20140521215744



# Table of Contents

---

## Introduction

About This Manual.....	3
Symbols Glossary.....	3
California Proposition 65.....	5
Perchlorate.....	5
Ford Credit.....	5
Replacement Parts Recommendation.....	6
Special Notices.....	6
Mobile Communications Equipment.....	7
Export Unique Options.....	7

## Steering Wheel

Adjusting the Steering Wheel.....	8
Cruise Control.....	8

## Wipers and Washers

Windshield Wipers.....	9
Windshield Washers.....	9

## Lighting

Lighting Control.....	10
Instrument Lighting Dimmer.....	10
Daytime Running Lamps.....	11
Direction Indicators.....	11

## Instrument Cluster

Gauges.....	12
Warning Lamps and Indicators.....	13
Audible Warnings and Indicators.....	15

## Information Displays

General Information.....	16
Information Messages.....	17

## Starting and Stopping the Engine

General Information.....	20
Ignition Switch.....	20

Starting a Gasoline Engine.....	20
---------------------------------	----

## Fuel and Refueling

Safety Precautions.....	22
Fuel Quality.....	23
Running Out of Fuel.....	23
Refueling.....	24
Fuel Consumption.....	25
Emission Control System.....	26

## Transmission

Automatic Transmission.....	29
-----------------------------	----

## Brakes

General Information.....	33
Hints on Driving With Anti-Lock Brakes.....	33
Parking Brake.....	34

## Cruise Control

Principle of Operation.....	35
Using Cruise Control.....	35

## Load Carrying

Load Limit.....	36
-----------------	----

## Towing

Towing a Trailer.....	42
Recommended Towing Weights.....	43
Essential Towing Checks.....	44
Transporting the Vehicle.....	46
Towing the Vehicle on Four Wheels.....	47

## Driving Hints

Breaking-In.....	48
Economical Driving.....	48
Driving Through Water.....	49

## Roadside Emergencies

Roadside Assistance.....	50
--------------------------	----

# Table of Contents

---

Hazard Warning Flashers.....	51
Jump Starting the Vehicle.....	51

## Customer Assistance

Getting the Services You Need.....	54
In California (U.S. Only).....	55
The Better Business Bureau (BBB) Auto Line Program (U.S. Only).....	56
Utilizing the Mediation/Arbitration Program (Canada Only).....	56
Getting Assistance Outside the U.S. and Canada.....	57
Ordering Additional Owner's Literature.....	58
Reporting Safety Defects (U.S. Only).....	58
Reporting Safety Defects (Canada Only).....	59

## Fuses

Fuse Specification Chart.....	60
Changing a Fuse.....	71

## Maintenance

General Information.....	72
Under Hood Overview.....	73
Engine Oil Dipstick.....	75
Engine Oil Check.....	75
Engine Coolant Check.....	76
Automatic Transmission Fluid Check.....	79
Brake Fluid Check.....	80
Power Steering Fluid Check.....	82
Fuel Filter.....	83
Changing the 12V Battery.....	83
Changing the Engine Air Filter.....	85

## Vehicle Care

General Information.....	87
Cleaning the Exterior.....	87
Cleaning the Engine.....	87

Cleaning the Alloy Wheels.....	88
Vehicle Storage.....	88

## Wheels and Tires

Tire Care.....	91
Using Snow Chains.....	106
Changing a Road Wheel.....	107
Technical Specifications.....	110

## Capacities and Specifications

Engine Specifications.....	111
Motorcraft Parts.....	112
Vehicle Identification Number.....	113
Vehicle Certification Label.....	113
Transmission Code Designation.....	114
Technical Specifications.....	115

## Extended Service Plan (ESP)

Extended Service Plan (ESP).....	119
----------------------------------	-----

## Scheduled Maintenance

General Maintenance Information.....	121
Normal Scheduled Maintenance.....	124
Special Operating Conditions Scheduled Maintenance.....	126
Scheduled Maintenance Record.....	128

# Introduction

## ABOUT THIS MANUAL

Thank you for choosing Ford. We recommend that you take some time to get to know your vehicle by reading this manual. The more that you know about it, the greater the safety and pleasure you will get from driving it.

### WARNING



Driving while distracted can result in loss of vehicle control, crash and injury. We strongly recommend that you use extreme caution when using any device that may take your focus off the road. Your primary responsibility is the safe operation of your vehicle. We recommend against the use of any handheld device while driving and encourage the use of voice-operated systems when possible. Make sure you are aware of all applicable local laws that may affect the use of electronic devices while driving.

**Note:** This manual describes product features and options available throughout the range of available models, sometimes even before they are generally available. It may describe options not fitted to your vehicle.

**Note:** Some of the illustrations in this manual may show features as used in different models, so may appear different to you on your vehicle. However, the essential information in the illustrations is always correct.

**Note:** Always use and operate your vehicle in line with all applicable laws and regulations.

**Note:** Pass on this manual when selling your vehicle. It is an integral part of the vehicle.

**Note:** Either Ford Motor Company or an authorized Ford dealer may have originally sold this incomplete vehicle to a vehicle modifier who upfitted it. As a result, some of the options and features on this vehicle may differ from what we describe in this manual.

This manual may qualify the location of a component as left-hand side or right-hand side. The side is determined when facing forward in the seat.

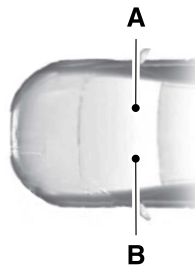

E154903

- A Right-hand side
- B Left-hand side

## Protecting the Environment

You must play your part in protecting the environment. Correct vehicle usage and the authorized disposal of waste, cleaning and lubrication materials are significant steps toward this aim.

## SYMBOLS GLOSSARY

These are some of the symbols you may see on your vehicle.



Safety alert



See Owner's Manual

# Introduction



Air conditioning system



Anti-lock braking system



Avoid smoking, flames or sparks



Battery



Battery acid



Brake fluid - non petroleum based



Brake system



Cabin air filter



Check fuel cap



Child safety door lock or unlock



Child seat lower anchor



Child seat tether anchor



Cruise control



Do not open when hot



Engine air filter



Engine coolant



Engine coolant temperature



Engine oil



Explosive gas



Fan warning



Fasten safety belt



Front airbag



Front fog lamps



Fuel pump reset



Fuse compartment



Hazard warning flashers



Heated rear window



Heated windshield



Interior luggage compartment release

# Introduction



Jack



Keep out of reach of children



Lighting control



Low tire pressure warning



Maintain correct fluid level



Note operating instructions



Panic alarm



Parking aid



Parking brake



Power steering fluid



Power windows front/rear



Power window lockout



Service engine soon



Side airbag



Shield the eyes



Stability control



Windshield wash and wipe

## CALIFORNIA PROPOSITION 65

### WARNING



Some constituents of engine exhaust, certain vehicle components, certain fluids contained in vehicles and certain products of component wear contain or emit chemicals known to the State of California to cause cancer and birth defects or other reproductive harm.

## PERCHLORATE

Certain components in your vehicle such as airbag modules, safety belt pretensioners and remote control batteries may contain perchlorate material. Special handling may apply for service or vehicle end of life disposal. For more information visit:

### Web Address

[www.dtsc.ca.gov/hazardouswaste/perchlorate](http://www.dtsc.ca.gov/hazardouswaste/perchlorate)

## FORD CREDIT

### (U.S. Only)

Ford Credit offers a full range of financing and lease plans to help you acquire your vehicle. If you have financed or leased your vehicle through Ford Credit, thank you for your business.



# Introduction

---

For your convenience we offer a number of ways to contact us, as well as to help manage your account.

Phone: 1-800-727-7000

For more information regarding Ford Credit, as well as to access Account Manager, please go to [www.fordcredit.com](http://www.fordcredit.com).

## REPLACEMENT PARTS RECOMMENDATION

Your vehicle has been built to the highest standards using quality parts. We recommend that you demand the use of genuine Ford and Motorcraft parts whenever your vehicle requires scheduled maintenance or repair. You can clearly identify genuine Ford and Motorcraft parts by looking for the Ford, FoMoCo or Motorcraft branding on the parts or their packaging.

## Scheduled Maintenance and Mechanical Repairs

One of the best ways for you to make sure that your vehicle provides years of service is to have it maintained in line with our recommendations using parts that conform to the specifications detailed in this Owner's Manual. Genuine Ford and Motorcraft parts meet or exceed these specifications.

## Collision Repairs

We hope that you never experience a collision, but accidents do happen. Genuine Ford replacement collision parts meet our stringent requirements for fit, finish, structural integrity, corrosion protection and dent resistance. During vehicle

development we validate these parts deliver the intended level of protection as a whole system. A great way to know for sure you are getting this level of protection is to use genuine Ford replacement collision parts.

## Warranty on Replacement Parts

Genuine Ford and Motorcraft replacement parts are the only replacement parts that benefit from a Ford Warranty. Damage caused to your vehicle as a result of the failure of non-Ford parts may not be covered by the Ford Warranty. For additional information, refer to the terms and conditions of the Ford Warranty.

## SPECIAL NOTICES

### New Vehicle Limited Warranty

For a detailed description of what is covered and what is not covered by your vehicle's New Vehicle Limited Warranty, refer to the Warranty Manual that is provided to you along with your Owner's Manual.

### Special Instructions

For your added safety, your vehicle is fitted with sophisticated electronic controls.

#### WARNINGS



Failure to follow the specific warnings and instructions could result in personal injury.



Front seat mounted rear-facing child or infant seats should **NEVER** be placed in front of an active passenger airbag.

---

# Introduction

---

## MOBILE COMMUNICATIONS EQUIPMENT

Using mobile communications equipment is becoming increasingly important in the conduct of business and personal affairs. However, you must not compromise your own or others' safety when using such equipment. Mobile communications can enhance personal safety and security when appropriately used, particularly in emergency situations. Safety must be paramount when using mobile communications equipment to avoid negating these benefits. Mobile communication equipment includes, but is not limited to, cellular phones, pagers, portable email devices, text messaging devices and portable two-way radios.

### WARNING



Driving while distracted can result in loss of vehicle control, crash and injury. We strongly recommend that you use extreme caution when using any device that may take your focus off the road. Your primary responsibility is the safe operation of your vehicle. We recommend against the use of any hand-held device while driving and encourage the use of voice-operated systems when possible. Make sure you are aware of all applicable local laws that may affect the use of electronic devices while driving.

---

## EXPORT UNIQUE OPTIONS

For your particular global region, your vehicle may be equipped with features and options that are different from the features and options that are described in this Owner's Manual. A market unique supplement may be supplied that complements this book. By referring to the market unique supplement, if provided, you can properly identify those features, recommendations and specifications that

are unique to your vehicle. This Owner's Manual is written primarily for the U.S. and Canadian Markets. Features or equipment listed as standard may be different on units built for Export. **Refer to this Owner's Manual for all other required information and warnings.**

# Steering Wheel

## ADJUSTING THE STEERING WHEEL

### WARNING

 Do not adjust the steering wheel when your vehicle is moving.

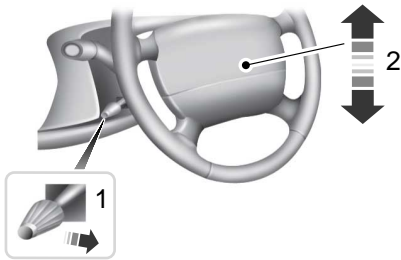

E161517

1. Pull and hold the steering wheel release lever.
2. Adjust the steering wheel to the desired position then release the lever.

## CRUISE CONTROL



E161518

See **Cruise Control** (page 35).

# Wipers and Washers

## WINDSHIELD WIPERS

**Note:** Fully defrost the windshield before switching on the windshield wipers.

**Note:** Make sure the windshield wipers are switched off before entering a car wash.

**Note:** Clean the windshield and wiper blades if they begin to leave streaks or smears. If that doesn't resolve the issue, install new wiper blades.

**Note:** Do not operate the wipers on a dry windshield. This may scratch the glass, damage the wiper blades or cause the wiper motor to burn out. Always use the windshield washers before wiping a dry windshield.



E161461

Rotate the end of the control:

- away from you to increase the wiper speed
- toward you to decrease the wiper speed

## WINDSHIELD WASHERS

**Note:** Do not operate the wipers on a dry windshield. This may scratch the glass, damage the wiper blades or cause the wiper motor to burn out. Always use the windshield washer before wiping a dry windshield.

**Note:** Do not operate the washers when the washer reservoir is empty. This may cause the washer pump to overheat.

Press the end of the stalk to activate the washer.

- A brief press causes a single wipe without washer fluid.
- A quick press and hold causes the wipers to swipe three times with washer fluid.
- A long press and hold will activate the wipers and washer fluid for up to 10 seconds.



E161462

# Lighting

## LIGHTING CONTROL

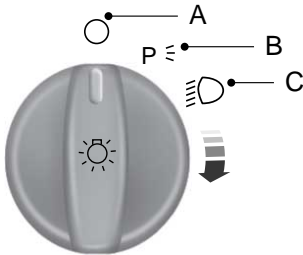

E161456

- A Off
- B Parking lamps, instrument panel lamps, license plate lamps and tail lamps
- C Headlamps

## High Beams

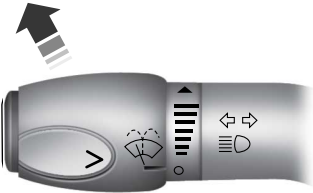

E161457

Push the lever forward to switch the high beams on.

Push the lever forward again or pull the lever toward you to switch the high beams off.

## Headlamp Flasher

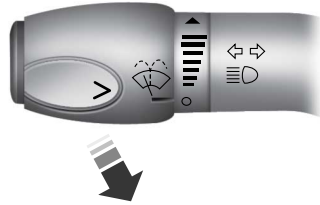

E161458

Pull the lever toward you slightly and release it to flash the headlamps.

## INSTRUMENT LIGHTING DIMMER

**Note:** If you disconnect the battery or it becomes discharged, the dimmer switch will require re-calibration. Rotate the dimmer switch from the full dim position to the full dome/on position to reset.

**Note:** Move the control to the full upright position, past detent, to turn on the interior lamps.

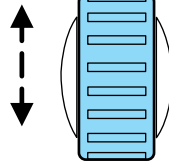

E161459

Move the control up or down to adjust the intensity of the panel lighting.

# Lighting

## DAYTIME RUNNING LAMPS (If Equipped)

### WARNING



Always remember to switch your headlamps on in low light situations or during inclement weather. The system does not activate the tail lamps and may not provide adequate lighting during these conditions. Failure to activate your headlamps under these conditions may result in a collision.

The system switches the low beam headlamps on at a reduced intensity in daylight conditions.

To switch the system on, switch the ignition on, and switch the lighting control to the off, autolamp or parking lamp position.

## DIRECTION INDICATORS



E161460

Push the lever up or down to use the direction indicators.

**Note:** Tap the lever up or down to make the direction indicators flash three times to indicate a lane change.

# Instrument Cluster

## GAUGES

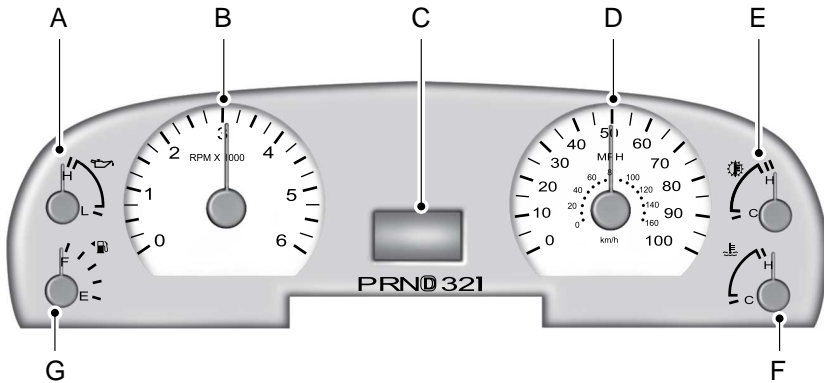

E161505

- A Engine oil pressure gauge
- B Tachometer
- C Information display
- D Speedometer.
- E Transmission fluid temperature gauge
- F Engine coolant temperature gauge
- G Fuel gauge

### Engine Oil Pressure Gauge

Indicates engine oil pressure. The needle should stay in the normal operating range (between L and H). If the needle falls below the normal range, stop the vehicle, turn off the engine and check the engine oil level. Add oil if needed. If the oil level is correct, have your vehicle checked by your authorized dealer.

### Speedometer

Indicates vehicle speed. Vehicle speed is limited to either 65 mph (105 km/h) or 75 mph (120 km/h).

### Transmission Fluid Temperature Gauge

#### Normal area

The transmission fluid is within the normal operating temperature (between H and C).

# Instrument Cluster

## Yellow area

The transmission fluid is higher than normal operating temperature. This can be caused by special operation conditions (i.e. snowplowing, towing or off-road use). Operating the transmission for extended periods of time with the gauge in the yellow area may cause internal transmission damage. Altering the severity of the driving conditions is recommended to lower the transmission temperature into the normal range.

## Red area

The transmission fluid is overheating. Stop the vehicle to allow the temperature to return to normal range.

If the gauge is operating in the yellow or red area, stop the vehicle and verify the airflow is not restricted such as snow or debris blocking airflow through the grill. If the gauge continues to show high temperatures, see your authorized dealer.

## Engine Coolant Temperature Gauge

### WARNING



Never remove the coolant reservoir cap while the engine is running or hot.

At normal operating temperature, the needle will remain in the center section.

**Note:** *Do not restart the engine until the cause of overheating has been resolved.*

If the needle enters the red section, the engine is overheating. Stop the engine, switch the ignition off and determine the cause once the engine has cooled down.

## Fuel Gauge

Switch the ignition on. The fuel gauge will indicate approximately how much fuel is left in the fuel tank. The fuel gauge may vary slightly when your vehicle is moving or on a gradient. The arrow adjacent to the fuel pump symbol indicates on which side of the vehicle the fuel filler door is located.

## WARNING LAMPS AND INDICATORS

The following warning lamps and indicators will alert you to a vehicle condition that may become serious. Some lamps will illuminate when you start your vehicle to make sure they work. If any lamps remain on after starting your vehicle, refer to the respective system warning lamp for further information.

**Note:** *Some warning indicators appear in the information display and function the same as a warning lamp but do not display when you start your vehicle.*

## Anti-Lock Braking System



If it illuminates when you are driving, this indicates a malfunction. You will continue to have the normal braking system (without ABS) unless the brake system warning lamp is also illuminated. Have the system checked by your authorized dealer.

## Battery



If it illuminates while driving, it indicates a malfunction. Switch off all unnecessary electrical equipment and have the system checked by your authorized dealer immediately.



# Instrument Cluster

## Brake System



Illuminates when you engage the parking brake with the ignition on.

If it illuminates when you are driving, check that the parking brake is not engaged. If the parking brake is not engaged, this indicates low brake fluid level or a brake system malfunction. Have the system checked immediately by your authorized dealer.

### WARNING



Driving your vehicle with the warning lamp on is dangerous. A significant decrease in braking performance may occur. It will take you longer to stop your vehicle. Have your vehicle checked by your authorized dealer immediately. Driving extended distances with the parking brake engaged can cause brake failure and the risk of personal injury.

## Brake Reserve System (If Equipped)



Illuminates to indicate normal hydromax booster reserve system activation when the engine is off and the service brake pedal is applied.

This light may also illuminate momentarily if the engine is running and the driver turns the steering wheel fully in one direction while braking.

If the light remains on while the engine is running, this indicates inadequate hydraulic booster pressure or reserve pump system failure. Stop the vehicle as soon as possible and seek service immediately by your authorized dealer.

## Cruise Control (If Equipped)



Illuminates when you switch this feature on. See **Using Cruise Control** (page 35).

## Direction Indicator



Illuminates when the left or right turn signal or the hazard warning flasher is turned on. If the indicators stay on or flash faster, check for a burned out bulb.

## Electronic Throttle Control



Illuminates when the engine has defaulted to a limp-home operation. See your authorized dealer as soon as possible.

## Fasten Safety Belt



It will illuminate and a chime will sound to remind you to fasten your safety belt.

## High Beam



Illuminates when you switch the high beam headlamps on. It will flash when you use the headlamp flasher.

## Service Engine Soon



If the service engine soon indicator light stays illuminated after the engine is started, it indicates that the On-Board Diagnostics (OBD-II) system has detected a malfunction of the vehicle emissions control system. Refer to On-Board Diagnostics (OBD-II) in the Fuel and Refueling chapter for more information about having your vehicle serviced. See **Emission Control System** (page 26).

# Instrument Cluster

---

If the light is blinking, engine misfire is occurring which could damage your catalytic converter. Drive in a moderate fashion (avoid heavy acceleration and deceleration) and have your vehicle serviced immediately.

**Note:** *Under engine misfire conditions, excessive exhaust temperatures could damage the catalytic converter or other vehicle components.*

The service engine soon indicator light illuminates when the ignition is first turned on prior to engine start to check the bulb and to indicate whether the vehicle is ready for Inspection/Maintenance (I/M) testing.

Normally, the service engine soon light will stay on until the engine is cranked, then turn itself off if no malfunctions are present. However, if after 15 seconds the service engine soon light blinks eight times, it means that the vehicle is not ready for I/M testing. See **Emission Control System** (page 26).

## **Transmission Tow/Haul (If Equipped)**



Illuminates when the tow/haul feature has been activated. If the light flashes steadily, have the system serviced immediately, damage to the transmission could occur.

## **AUDIBLE WARNINGS AND INDICATORS**

### **Fail-Safe Cooling Warning Chime**

Sounds when the coolant gauge pointer has moved to hot. There are three stages of chimes:

- Stage 1 is a single chime when the engine temperature begins to overheat.
- Stage 2 is multiple chimes and engine power becomes limited in order to help cool the engine.
- Stage 3 is multiple chimes and the engine will shut down.

### **Headlamps On Warning Chime**

Sounds when you remove the key from the ignition and open the driver's door and you have left the headlamps or parking lamps on.

### **Key in Ignition Warning Chime**

Sounds when you open the driver's door and you have left the key in the ignition with it in the off or accessory position.

### **Parking Brake On Warning Chime**

Sounds when you have left the parking brake on and drive your vehicle. If the warning chime remains on after you have released the parking brake, have the system checked by your authorized dealer immediately.

# Information Displays

## GENERAL INFORMATION

### WARNING



Driving while distracted can result in loss of vehicle control, crash and injury. We strongly recommend that you use extreme caution when using any device that may take your focus off the road. Your primary responsibility is the safe operation of your vehicle. We recommend against the use of any hand-held device while driving and encourage the use of voice-operated systems when possible. Make sure you are aware of all applicable local laws that may affect the use of electronic devices while driving.

Various systems on your vehicle can be controlled using the information display controls on the steering wheel. Corresponding information is displayed in the information display.

## Information Display Controls

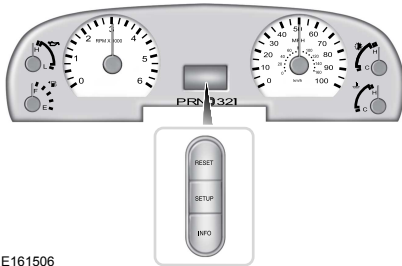

E161506

- Press the info button to scroll through trip, outside air temperature, engine hours and miles to empty.
- Press the setup button to scroll through various vehicle feature settings.
- Press the reset button to choose settings, reset information and confirm messages.

## Info



E161507

Press the INFO button repeatedly to cycle through the following features:

### TRIP

Registers the distance of individual journeys. Press and release the INFO button until the TRIP appears in the display. Press and hold the RESET button to reset

### XXX° (outside air temperature)

This displays the outside temperature.

### MILES (km) TO E

This displays an estimate of approximately how far you can drive with the fuel remaining in your tank under normal driving conditions. Remember to turn the ignition off when refueling to allow this feature to correctly detect the added fuel.

The DTE function will display a message in the information display when you have approximately 50 miles (80 km), to empty. Press RESET to clear this warning message. It will return at approximately 25 miles (40 km), 10 miles (16 km) and 0 miles (0 km) miles to empty.

DTE is calculated using a running average fuel economy, which is based on your recent driving history of 500 miles (800 km).

# Information Displays

## ENG HRS

Registers the accumulated time the engine has been running.

## System check and vehicle feature customization



E161508

Press the SETUP button repeatedly to cycle the message center through the following features:

**Note:** When returning to the SETUP menu and a non-English language has been selected, HOLD RESET FOR ENGLISH will be displayed to change back to English. Press and hold the RESET button to change back to English.

## PRESS RESET FOR SYS CHECK

When this message appears, press the RESET button and the message center will begin to cycle through the following systems and provide a status of the item if needed.

**Note:** Some systems show a message only if a condition is present

- ENGINE TEMP
- TRANS TEMP
- OIL PRESSURE
- BRAKE FLUID LEVEL
- FUEL LEVEL (if equipped)

## UNITS

Displays the current units English or Metric. Press the RESET button to change from English to Metric.

## ENGLISH RESET FOR NEW

Allows you to choose which language the message center will display in. Selectable languages are English, Spanish, or French.

Press the RESET button to cycle the message center through English, Spanish and French language choices. Press and hold the RESET button for two seconds to set the language choice.

## INFORMATION MESSAGES

**Note:** Depending on the vehicle options equipped with your vehicle, not all of the messages will display or be available. Certain messages may be abbreviated or shortened depending upon which cluster type you have.

Press the RESET button to acknowledge and remove some messages from the information display. Other messages will be removed automatically after a short time.

Certain messages need to be confirmed before you can access the menus.

## Information Displays

### Engine

Message	Action
REDUCED ENGINE POWER	The engine is overheating. Stop your vehicle as soon as safely possible, turn off the engine. If the warning stays on followed by an indicator chime or continues to come on, contact an authorized dealer as soon as possible. Never remove the coolant reservoir cap while the engine is running or hot.
STOP ENGINE SAFELY	The engine is overheating. Stop your vehicle as soon as safely possible, turn off the engine. If the warning stays on followed by an indicator chime or continues to come on, contact an authorized dealer as soon as possible.
CHECK ENGINE TEMPERATURE	The engine coolant is overheating. Stop your vehicle as soon as safely possible, turn off the engine and let it cool. Check the coolant and coolant level. If the warning stays on or continues to come on, contact an authorized dealer as soon as possible.
FUEL LEVEL LOW	A early reminder of a low fuel condition.

### Maintenance

Message	Action
LOW OIL PRESSURE	The engine oil pressure is low. Check the level of the engine oil. If the oil level is OK and this warning persists, shut down the engine immediately and contact an authorized dealer as soon as possible. See <b>Engine Oil Check</b> (page 75).
BRAKE FLUID LEVEL LOW	The brake fluid level is low and the brake system should be inspected immediately. See <b>Brake Fluid Check</b> (page 80).
CHECK FUEL CAP	The fuel cap is loose, not seated properly or off. Stop your vehicle when convenient, turn off the engine and check that you inserted the fuel cap is properly. Rotate the cap until you hear a click. The warning message switch off after a proper drive cycle is completed. See <b>Emission Control System</b> (page 26). If the warning message remains on or continues to comes back on, see an authorized dealer as soon as possible.

# Information Displays

---

## Transmission

<b>Message</b>	<b>Action</b>
CHECK TRANS TEMPERATURE	The transmission fluid is overheating. This warning may appear when towing heavy loads or when driving in a low gear at a high speed for an extended period of time. Stop your vehicle as soon as safely possible, turn off the engine and let the transmission cool.

# Starting and Stopping the Engine

## GENERAL INFORMATION

### WARNINGS



Extended idling at high engine speeds can produce very high temperatures in the engine and exhaust system, creating the risk of fire or other damage.



Do not park, idle or drive your vehicle on dry grass or other dry ground cover. The emission system heats up the engine compartment and exhaust system, creating the risk of fire.



Do not start the engine in a closed garage or in other enclosed areas. Exhaust fumes can be toxic. Always open the garage door before you start the engine.



If you smell exhaust fumes inside your vehicle, have your vehicle checked by an authorized dealer immediately. Do not drive your vehicle if you smell exhaust fumes.

If you disconnect the battery, your vehicle may exhibit some unusual driving characteristics for approximately 5 miles (8 kilometers) after you reconnect it. This is because the engine management system must realign itself with the engine. You can disregard any unusual driving characteristics during this period.

The powertrain control system meets all Canadian interference-causing equipment standard requirements regulating the impulse electrical field or radio noise.

When you start the engine, avoid pressing the accelerator pedal before and during operation. Only use the accelerator pedal when you have difficulty starting the engine.

## IGNITION SWITCH

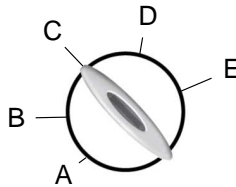

E161572

**A (accessory)** - Allows the electrical accessories, such as the radio, to operate while the engine is not running.

**Note:** Do not leave the ignition key in this position for too long. This could cause your vehicle battery to lose charge.

**B (lock)** - Locks the gearshift lever and allows key removal.

**C (off)** - The ignition is off.

**Note:** When you switch the ignition off and leave your vehicle, do not leave your key in the ignition. This could cause your vehicle battery to lose charge.

**D (on)** - All electrical circuits are operational and the warning lamps and indicators illuminate.

**E (start)** - Cranks the engine.

## STARTING A GASOLINE ENGINE

When you start the engine, the idle speed increases, this helps to warm up the engine. If the engine idle speed does not slow down automatically, have your vehicle checked by an authorized dealer.

# Starting and Stopping the Engine

---

Before starting the engine check the following:

- Make sure all occupants have fastened their safety belts.
- Make sure the headlamps and electrical accessories are off.
- Make sure the parking brake is on.
- Move the transmission selector lever to position **P**.
- Turn the ignition key to the on position.

**Note:** Do not touch the accelerator pedal.

1. Fully press the brake pedal.
2. Turn the key to the start position to start the engine. Release the key when the engine starts.

**Note:** The engine may continue cranking for up to 15 seconds or until it starts.

**Note:** If you cannot start the engine on the first try, wait for a short period and try again.

## Failure to Start

If you cannot start the engine after three attempts, wait 10 seconds and follow this procedure:

1. Fully press the brake pedal.
2. Fully press the accelerator pedal and hold it there.
3. Start the engine.

## Stopping the Engine When Your Vehicle is Stationary

1. Move the transmission selector lever to position **P**.
2. Turn the key to the off position.
3. Apply the parking brake.

## Stopping the Engine When Your Vehicle is Moving

### WARNING



Switching off the engine when the vehicle is still moving will result in a loss of brake and steering assistance. The steering will not lock, but higher effort will be required. When the ignition is switched off, some electrical circuits, warning lamps and indicators may also be off.

1. Move the transmission selector lever to position **N** and use the brakes to bring your vehicle to a safe stop.
2. When your vehicle has stopped, move the transmission selector lever to position **P** and turn the key to the off position.
3. Apply the parking brake.

## Guarding Against Exhaust Fumes

### WARNING



If you smell exhaust fumes inside your vehicle, have your vehicle checked by your authorized dealer immediately. Do not drive your vehicle if you smell exhaust fumes. Carbon monoxide is present in exhaust fumes. Take precautions to avoid its dangerous effects.

## Important Ventilating Information

If you stop your vehicle and leave the engine idling for long periods of time, we recommend that you do one of the following:

- Open the windows at least 1 inch (2.5 centimeters)
- Set your climate control to outside air.



# Fuel and Refueling

---

## SAFETY PRECAUTIONS

### WARNINGS



Do not overfill the fuel tank. The pressure in an overfilled tank may cause leakage and lead to fuel spray and fire.



The fuel system may be under pressure. If you hear a hissing sound near the fuel filler door, do not refuel until the sound stops. Otherwise, fuel may spray out, which could cause serious personal injury.



Automotive fuels can cause serious injury or death if you misuse or mishandle them.



Fuel ethanol and gasoline may contain benzene, which is a cancer-causing agent.



When refueling always shut the engine off and never allow sparks or open flames near the filler neck.

Never smoke or use a cell phone while refueling. Fuel vapor is extremely hazardous under certain conditions. Avoid inhaling excess fumes.



The flow of fuel through a fuel pump nozzle can produce static electricity, which can cause a fire if you pump fuel into an ungrounded fuel container.

---

Observe the following guidelines when handling automotive fuel:

- Extinguish all smoking materials and any open flames before refueling your vehicle.
- Automotive fuels can be harmful or fatal if swallowed. Fuel such as gasoline is highly toxic and if swallowed can cause death or permanent injury. If swallowed, call a physician immediately, even if no symptoms are immediately apparent. The toxic effects of fuel may not be visible for hours.
- Avoid inhaling fuel vapors. Inhaling too much fuel vapor of any kind can lead to eye and respiratory tract irritation. In severe cases, excessive or prolonged breathing of fuel vapor can cause serious illness and permanent injury.
- Avoid getting fuel liquid in your eyes. If you splash fuel in your eyes, remove contact lenses (if worn), flush with water for 15 minutes and seek medical attention. Failure to seek proper medical attention could lead to permanent injury.
- Fuels can also be harmful if absorbed through the skin. If you splash fuel on your skin, clothing or both, promptly remove contaminated clothing and wash your skin thoroughly with soap and water. Repeated or prolonged skin contact with fuel liquid or vapor causes skin irritation.
- Be particularly careful if you are taking "Antabuse" or other forms of disulfiram for the treatment of alcoholism. Breathing gasoline vapors, or skin contact could cause an adverse reaction. In sensitive individuals, serious personal injury or sickness may result. If you splash fuel on your skin, promptly wash your skin thoroughly with soap and water. Consult a physician immediately if you experience an adverse reaction.

# Fuel and Refueling

## FUEL QUALITY

**Note:** *Use of any fuel other than those recommended may cause powertrain damage, a loss of vehicle performance, and repairs may not be covered under warranty.*

### Choosing the Right Fuel

Use only UNLEADED gasoline or UNLEADED gasoline blended with a maximum of 15% ethanol in your gasoline vehicle. If your vehicle is a Flex Fuel Vehicle (FFV), it will have a yellow bezel placed over the fuel fill inlet.

Do not use:

- fuels containing more than 15% ethanol or E-85 fuel
- fuels containing methanol
- fuels containing metallic based additives, including manganese-based compounds
- fuels containing the octane booster additive, methylcyclopentadienyl manganese tricarbonyl (MMT)
- leaded-fuel (The use of leaded fuel is prohibited by law)

**Note:** *Use of any fuel other than the recommended fuel can cause powertrain damage, impair the emission control system or cause loss of vehicle performance. Any damage to the vehicle that is caused by the use of fuel not recommended will not be covered under warranty.*

### Octane Recommendations



E161513

Regular unleaded gasoline with a pump (R+M)/2 octane rating of 87 is recommended. Some stations offer fuels posted as Regular with an octane rating below 87, particularly in high altitude areas. Fuels with octane levels below 87 are not recommended.

Do not be concerned if your engine sometimes knocks lightly. However, if it knocks heavily under most driving conditions while you are using fuel with the recommended octane rating, see your authorized dealer to prevent any engine damage.

## RUNNING OUT OF FUEL

Avoid running out of fuel because this situation may have an adverse effect on powertrain components.











If you have run out of fuel:

- You may need to cycle the ignition from off to on several times after refueling to allow the fuel system to pump the fuel from the tank to the engine. On restarting, cranking time will take a few seconds longer than normal. With keyless ignition, just start the engine. Crank time will be longer than usual.
- Normally, adding 1 gallon (3.8 liters) of fuel is enough to restart the engine. If the vehicle is out of fuel and on a steep grade, more than 1 gallon (3.8 liters) may be required.
- The service engine soon indicator may come on. For more information on the service engine soon indicator, See **Warning Lamps and Indicators** (page 13).

# Fuel and Refueling

## REFUELING

### WARNINGS



-  Fuel vapor burns violently and a fuel fire can cause severe injuries.
-  Read and follow all the instructions on the pump island.
-  Turn off your engine when you are refueling.
-  Do not smoke if you are near fuel or refueling your vehicle.
-  Keep sparks, flames and smoking materials away from fuel.
-  Stay outside your vehicle and do not leave the fuel pump unattended when refueling your vehicle. This is against the law in some places.
-  Keep children away from the fuel pump; never let children pump fuel.
-  Do not use personal electronic devices while refueling.
-  Wait at least 10 seconds before removing the fuel pump nozzle to allow any residual fuel to drain into the fuel tank.
-  Stop refueling after the fuel pump nozzle automatically shuts off for the second time. Failure to follow this will fill the expansion space in the fuel tank and could lead to fuel overflowing.
-  Do not remove the fuel pump nozzle from its fully inserted position when refueling.

Use the following guidelines to avoid electrostatic charge build-up when filling an ungrounded fuel container:

- Place approved fuel container on the ground.
- Do not fill a fuel container while it is in the vehicle (including the cargo area).
- Keep the fuel pump nozzle in contact with the fuel container while filling.
- Do not use a device that would hold the fuel pump handle in the fill position.

## Fuel Filler Cap

### WARNINGS

-  The fuel system may be under pressure. If you hear a hissing sound near the fuel filler door, do not refuel until the sound stops. Otherwise, fuel may spray out, which could cause serious personal injury.
-  If you do not use the proper fuel filler cap, excessive pressure or vacuum in the fuel tank may damage the fuel system or cause the fuel cap to disengage in a collision, which may result in possible personal injury.

**Note:** *If you must replace the fuel filler cap, replace it with a fuel filler cap that is designed for your vehicle. The customer warranty may be void for any damage to the fuel tank or fuel system if the correct genuine Ford, Motorcraft or other certified fuel filler cap is not used.*

Your fuel tank filler cap has an indexed design with a 1/4th turn on and off feature. When fueling your vehicle:

1. Put your vehicle in park (P).
2. Switch the engine off.
3. Carefully turn the filler cap counterclockwise until it spins off.
4. Pull to remove the cap from the fuel filler pipe.

# Fuel and Refueling

---

5. To install the cap, align the tabs on the cap with the notches on the filler pipe.
6. Turn the filler cap clockwise 1/4 of a turn clockwise until it clicks at least once.

If the Check Fuel Cap light or a Check Fuel Cap message appears in the instrument cluster and stays on after you start the engine, you may not have installed the fuel filler properly.

If the fuel cap light remains on, at the next opportunity, safely pull off of the road, remove the fuel filler cap, align the cap properly and reinstall it. The check fuel cap light or Check fuel cap message may not reset immediately. It may take several driving cycles for the indicators to turn off. A driving cycle consists of an engine start-up (after four or more hours with the engine off) followed by normal city and highway driving.

## FUEL CONSUMPTION

Empty reserve is the amount of fuel remaining in the tank after the fuel gauge indicates empty. The amount of usable fuel in the empty reserve varies and should not be relied upon to increase driving range.

- The usable capacity of the fuel tank is the amount of fuel that can be added into the tank after the gauge indicates empty
- The advertised capacity is the total fuel tank size. See **Capacities and Specifications** (page 111). It is the combined usable capacity plus the empty reserve.
- Due to the empty reserve, you may not be able to refuel the full amount of the advertised capacity of the fuel tank even when the fuel gauge reads empty.

## Filling the Tank

For consistent results when filling the fuel tank:

- Turn the ignition off before fueling; an inaccurate reading results if the engine is left running.
- Use the same fill rate (low-medium-high) each time the tank is filled.
- Allow no more than two automatic click-offs when filling.

Results are most accurate when the filling method is consistent.

## Calculating Fuel Economy

Do not measure fuel economy during the first 1000 miles (1600 kilometers) of driving (this is your engine's break-in period); a more accurate measurement is obtained after 2000 miles - 3000 miles (3200 kilometers - 4800 kilometers). Also, fuel expense, frequency of fill ups or fuel gauge readings are not accurate ways to measure fuel economy.

1. Fill the fuel tank completely and record the initial odometer reading.
2. Each time you fill the tank, record the amount of fuel added.
3. After at least 3 to 5 tank fill ups, fill the fuel tank and record the current odometer reading.
4. Subtract your initial odometer reading from the current odometer reading.
5. Calculate fuel economy by dividing miles traveled by gallons used (For Metric: Multiply liters used by 100, then divide by kilometers traveled).

# Fuel and Refueling

Keep a record for at least 1 month and record the type of driving (city or highway). This provides an accurate estimate of the vehicle's fuel economy under current driving conditions. Additionally, keeping records during summer and winter show how temperature impacts fuel economy. In general, lower temperatures mean lower fuel economy.

## Conditions

- Heavily loading a vehicle or towing a trailer may reduce fuel economy at any speed.
- Carrying unnecessary weight may reduce fuel economy (approximately 1 mpg [0.4 km/L] is lost for every 400 pounds [180 kilograms] of weight carried).
- Adding certain accessories to your vehicle (for example bug deflectors, rollbars/light bars, running boards, ski racks) may reduce fuel economy.
- Using fuel blended with alcohol may lower fuel economy.
- Fuel economy may decrease with lower temperatures during the first 8–10 miles (12–16 kilometers) of driving.
- Driving on flat terrain offers improved fuel economy as compared to driving on hilly terrain.
- Transmissions give their best fuel economy when operated in the top cruise gear and with steady pressure on the gas pedal.
- Close windows for high speed driving.

## EMISSION CONTROL SYSTEM

### WARNINGS



Do not park, idle, or drive your vehicle in dry grass or other dry ground cover. The emission system heats up the engine compartment and exhaust system, which can start a fire.



Exhaust leaks may result in entry of harmful and potentially lethal fumes into the passenger compartment. If you smell exhaust fumes inside your vehicle, have your dealer inspect your vehicle immediately. Do not drive if you smell exhaust fumes.

Your vehicle is equipped with various emission control components and a catalytic converter that will enable your vehicle to comply with applicable exhaust emission standards. To make sure that the catalytic converter and other emission control components continue to work properly:

- Use only the specified fuel listed.
- Avoid running out of fuel.
- Do not turn off the ignition while your vehicle is moving, especially at high speeds.
- Have the items listed in scheduled maintenance information performed according to the specified schedule.

The scheduled maintenance items listed in scheduled maintenance information are essential to the life and performance of your vehicle and to its emissions system.

If you use parts other than Ford, Motorcraft or Ford-authorized parts for maintenance replacements, or for service of components affecting emission control, such non-Ford parts should be the equivalent to genuine Ford Motor Company parts in performance and durability.

# Fuel and Refueling

Illumination of the service engine soon indicator, charging system warning light or the temperature warning light, fluid leaks, strange odors, smoke or loss of engine power could indicate that the emission control system is not working properly.

An improperly operating or damaged exhaust system may allow exhaust to enter the vehicle. Have a damaged or improperly operating exhaust system inspected and repaired immediately.

Do not make any unauthorized changes to your vehicle or engine. By law, vehicle owners and anyone who manufactures, repairs, services, sells, leases, trades vehicles, or supervises a fleet of vehicles are not permitted to intentionally remove an emission control device or prevent it from working. Information about your vehicle's emission system is on the Vehicle Emission Control Information Decal located on or near the engine. This decal also lists engine displacement

Please consult your warranty information for complete details.

## On-Board Diagnostics (OBD-II)

Your vehicle is equipped with an on-board diagnostics system (OBD-II) that monitors the engine's emission control system. This system protects the environment by ensuring that your vehicle continues to meet government emission standards. The OBD-II system also assists your authorized dealer in properly servicing your vehicle.



When the service engine soon indicator illuminates, the OBD-II system has detected a malfunction. Temporary malfunctions may cause the service engine soon indicator to illuminate.

Examples of temporary malfunctions are:

- the vehicle has run out of fuel—the engine may misfire or run poorly
- poor fuel quality or water in the fuel—the engine may misfire or run poorly
- the fuel fill inlet may not have been properly closed See **Refueling** (page 24).
- driving through deep water—the electrical system may be wet.

You can correct these temporary malfunctions by filling the fuel tank with good quality fuel, properly closing the fuel fill inlet or letting the electrical system dry out. After three driving cycles without these or any other temporary malfunctions present, the service engine soon indicator should stay off the next time you start the engine. A driving cycle consists of a cold engine startup followed by mixed city/highway driving. No additional vehicle service is required.

If the service engine soon indicator remains on, have your vehicle serviced at the first available opportunity. Although some malfunctions detected by the OBD-II may not have symptoms that are apparent, continued driving with the service engine soon indicator on can result in increased emissions, lower fuel economy, reduced engine and transmission smoothness, and lead to more costly repairs.

## Readiness for Inspection/Maintenance (I/M) Testing

Some state/provincial and local governments may have Inspection/Maintenance (I/M) programs to inspect the emission control equipment on your vehicle. Failure to pass this inspection could prevent you from getting a vehicle registration.

## Fuel and Refueling

---



If the service engine soon indicator is on or the bulb does not work, you may need to have the vehicle serviced. See On-Board Diagnostics (OBD-II).

Your vehicle may not pass the I/M test if the service engine soon indicator is on or not working properly (bulb is burned out), or if the OBD-II system has determined that some of the emission control systems have not been properly checked. In this case, your vehicle is not ready for I/M testing.

If the vehicle's engine or transmission has just been serviced, or the battery has recently run down or been replaced, the OBD-II system may indicate that the vehicle is not ready for I/M testing. To determine if the vehicle is ready for I/M testing, turn the ignition key to the on position for 15 seconds without cranking the engine. If the service engine soon indicator blinks eight times, it means that the vehicle is not ready for I/M testing; if the service engine soon indicator stays on solid, it means that the vehicle is ready for I/M testing.

The OBD-II system monitors the emission control system during normal driving. A complete check may take several days. If the vehicle is not ready for I/M testing, you may need to perform the following driving cycle consisting of mixed city and highway driving:

Drive on an expressway or highway for a steady 15 minutes, followed by 20 minutes of stop-and-go driving with at least four 30-second idle periods.

Allow the vehicle to sit for at least eight hours without starting the engine. Then, start the engine and complete the above driving cycle. The engine must warm up to its normal operating temperature. Once started, do not turn off the engine until the above driving cycle is complete. If the vehicle is still not ready for I/M testing, you will have to repeat the above driving cycle.

# Transmission

## AUTOMATIC TRANSMISSION

### WARNINGS



Always set the parking brake fully and make sure the gearshift is latched in P (Park). Turn the ignition to the off position and remove the key whenever you leave your vehicle.



Do not apply the brake pedal and accelerator pedal simultaneously. Applying both pedals simultaneously for more than three seconds will limit engine rpm, which may result in difficulty maintaining speed in traffic and could lead to serious injury.

### Understanding the Positions of Your Automatic Transmission

P R N D 3 2 1

E161511

This vehicle is equipped with an adaptive transmission shift strategy. Adaptive transmission shift strategy offers the optimal transmission operation and shift quality. When the vehicle's battery has been disconnected for any type of service or repair, the transmission will need to relearn the normal shift strategy parameters, much like having to reset your radio stations when your vehicle battery has been disconnected. The adaptive transmission shift strategy allows the transmission to relearn these operating parameters.

This learning process could take several transmission upshifts and downshifts; during this learning process, slightly firmer shifts may occur. After this learning process, normal shift feel and shift scheduling will resume.

### Putting your vehicle in or out of gear:

1. Fully press down the brake pedal.
2. Move the gearshift lever into the desired gear.
3. Come to a complete stop.
4. Move the gearshift lever and securely latch it in P (Park)

### P (Park)

This position locks the transmission and prevents the rear wheels from turning. Come to a complete stop before putting your vehicle into and out of P (Park)

### R (Reverse)

With the gearshift lever in R (Reverse), the vehicle will move backward. Always come to a complete stop before shifting into and out of R (Reverse).

### N (Neutral)

With the gearshift lever in N (Neutral), the vehicle can be started and is free to roll. Hold the brake pedal down while in this position.

### D (Overdrive) with tow/haul off

D (Overdrive) with tow/haul off is the normal driving position for the best fuel economy. The overdrive function allows automatic upshifts and downshifts through gears one through five.



# Transmission

## D (Overdrive) with tow/haul on



E161510

The tow/haul feature improves transmission operation when towing a trailer or a heavy load. All transmission gear ranges are available when using tow/haul.

**TOW HAUL** To activate tow/haul, press the button on the end of the gearshift lever. The TOW HAUL indicator light will illuminate in the instrument cluster.

Tow/haul delays upshifts to reduce frequency of transmission shifting. Tow/haul also provides engine braking in all forward gears when the transmission is in the D (Overdrive) position; this engine braking will slow the vehicle and assist the driver in controlling the vehicle when descending a grade. Depending on driving conditions and load conditions, the transmission may downshift, slow the vehicle and control the vehicle speed when descending a hill, without the accelerator pedal being pressed. The amount of downshift braking provided will vary based upon the amount the brake pedal is pressed.

Grade braking downshifts occur automatically when all three of the following occur:

- Positive vehicle acceleration (natural acceleration from driving on a decline) is sensed.
- Nearly all pressure is released from the accelerator pedal.
- A minimum amount of time has expired since the last grade braking downshift.

Grade braking downshift mode is immediately exited if the Tow/Haul mode is deactivated or if the accelerator pedal is depressed beyond a minimum threshold.

To deactivate the tow/haul feature and return to normal driving mode, press the button on the end of the gearshift lever. The TOW HAUL light will no longer be illuminated.

When you shut-off and restart the engine, the transmission will automatically return to normal D (Overdrive) mode (tow/haul off).

### WARNING

 Do not use the tow/haul feature when driving in icy or slippery conditions as the increased engine braking can cause the rear wheels to slide and the vehicle to swing around with the possible loss of vehicle control.

### 3 (Third)

Transmission starts and operates in third gear only

Used for improved traction on slippery roads. Selecting 3 (Third) provides engine braking.

### 2 (Second)

Use 2 (Second) to start-up on slippery roads or to provide additional engine braking on downgrades.

# Transmission

## 1 (First)

- Provides maximum engine braking
- Allows upshifts by moving gearshift lever
- The transmission will not downshift into 1 (First) at high speeds; it will downshift to a lower gear and then shift into 1 (First) when the vehicle reaches slower speeds.

### Forced downshifts

- Allowed in D (Overdrive) with the tow/haul feature on or off
- Press the accelerator to the floor
- Allows transmission to select an appropriate gear

## Brake-Shift Interlock

### WARNINGS



Do not drive your vehicle until you verify that the brake lamps are working.



If your brake lamps are not working properly or if you have disconnected the vehicle battery cables, the vehicle brake lamps and hazard flashers may not properly warn traffic of a vehicle breakdown or approaching danger, which can increase the risk of serious injury or death. To minimize the risk of serious injury or death, be aware of your surroundings, use other hazard signaling devices if available, and move the vehicle to a safe location away from traffic as soon as possible.



When doing this procedure, you will be taking the vehicle out of park which means the vehicle can roll freely. To avoid unwanted vehicle movement, always fully set the parking brake prior to doing this procedure. Use wheel chocks if appropriate.

### WARNINGS



If the parking brake is fully released, but the brake warning lamp remains illuminated, the brakes may not be working properly. See your authorized dealer.

Your vehicle is equipped with a brake-shift interlock feature that prevents the gearshift lever from being moved from P (Park) unless the brake pedal is pressed.

If you cannot move the gearshift lever out of P (Park) position with the ignition in the 4 (on) position and the brake pedal pressed, a malfunction may have occurred. It is possible that a fuse has blown or the vehicle's brake lamps are not operating properly. Refer to Fuses and relays in the Roadside Emergencies chapter. If the fuses and brake lamps are working properly, and the vehicle still will not shift out of (P) Park, see your authorized dealer for service.

In an emergency, to disable the malfunctioning brake-shift interlock feature in order to shift the vehicle from P (Park) follow these steps:

1. Apply the parking brake. Turn key to the lock position, and then remove the key.
2. Disconnect the negative (black) battery cable from the battery.
3. Insert the key and turn to the off position. Shift to N (Neutral).
4. Reconnect the negative (black) battery cable to the battery.
5. Start the vehicle.

**Note:** See your authorized dealer as soon as possible if this procedure is used.

# Transmission

---

## **If Your Vehicle Gets Stuck In Mud or Snow**

**Note:** *Do not rock the vehicle if the engine is not at normal operating temperature or damage to the transmission may occur.*

**Note:** *Do not rock the vehicle for more than a minute or damage to the transmission and tires may occur, or the engine may overheat.*

If your vehicle gets stuck in mud or snow, it may be rocked out by shifting between forward and reverse gears, stopping between shifts in a steady pattern. Press lightly on the accelerator in each gear.

# Brakes

## GENERAL INFORMATION

**Note:** Occasional brake noise is normal. If a metal-to-metal, continuous grinding or continuous squeal sound is present, the brake linings may be worn-out and should be inspected by an authorized dealer. If the vehicle has continuous vibration or shudder in the steering wheel while braking, the vehicle should be inspected by an authorized dealer.

**Note:** Brake dust may accumulate on the wheels, even under normal driving conditions. Some dust is inevitable as the brakes wear and does not contribute to brake noise. See **Cleaning the Alloy Wheels** (page 88).



See the Instrument Cluster chapter for information on the brake system warning light.

Wet brakes result in reduced braking efficiency. Gently press the brake pedal a few times when driving from a car wash or standing water to dry the brakes.

### Brake Over Accelerator

In the event the accelerator pedal becomes stuck or entrapped, apply steady and firm pressure to the brake pedal to slow the vehicle and reduce engine power. If you experience this condition, apply the brakes and bring your vehicle to a safe stop. Turn the engine off, shift to position **P** and apply the parking brake, and then inspect the accelerator pedal for any interferences. If none are found and the condition persists, have your vehicle towed to the nearest authorized dealer.

### Hydraulic brake booster system (Hydroboost or Hydromax)

The Hydroboost and Hydromax systems receive fluid pressure from the power steering pump to provide power assist during braking.

The Hydromax booster receives backup pressure from the reserve system electric pump whenever the fluid in the power steering system is not flowing. When the engine is off, the pump will turn on if the brake pedal is applied, or if the ignition is turned to the on position.

The sound of the pump operating may be heard by the driver, but this is a normal characteristic of the system.

The reserve system provides reduced braking power, so the vehicle should be operated under these conditions with caution, and only to seek service repair and remove the vehicle from the roadway.

**Note:** For Hydromax-equipped vehicles operating under normal conditions, the noise of the fluid flowing through the booster may be heard whenever the brake is applied. This condition is normal. Vehicle service is not required.

If braking performance or pedal response becomes very poor, even when the pedal is strongly pressed, it may indicate the presence of air in the hydraulic system or leakage of fluid. Stop the vehicle safely as soon as possible and seek service immediately.

## HINTS ON DRIVING WITH ANTI-LOCK BRAKES

**Note:** When the system is operating, the brake pedal will pulse and may travel further. Maintain pressure on the brake pedal. You may also hear a noise from the system. This is normal.

The anti-lock braking system will not eliminate the risks when:

- You drive too closely to the vehicle in front of you.
- Your vehicle is hydroplaning.

# Brakes

---

- You take corners too fast.
- The road surface is poor.

## PARKING BRAKE

### WARNING



Always set the parking brake fully and make sure the transmission selector lever is placed in position **P**. Failure to set the parking brake and engage park could result in vehicle roll-away, property damage or bodily injury. Turn the ignition to the lock position and remove the key whenever you leave your vehicle.

Apply the parking brake whenever your vehicle is parked. Press the pedal downward to set the parking brake.



The brake warning lamp in the instrument cluster illuminates when the ignition is turned on until the parking brake is released.

The parking brake is not recommended to stop a moving vehicle. However, if the normal brakes fail, the parking brake can be used to stop your vehicle in an emergency. Since the parking brake applies only the transmission mounted parking brake assembly, the vehicle's stopping distance will increase greatly and the handling of your vehicle will be adversely affected.

To release the parking brake:

1. Press your foot brake pedal firmly.
2. Pull the parking brake release lever.

# Cruise Control

## PRINCIPLE OF OPERATION

Cruise control lets you maintain a set speed without keeping your foot on the accelerator pedal. You can use cruise control when your vehicle speed is greater than 20 mph (30 km/h).

## USING CRUISE CONTROL

### WARNINGS



Do not use cruise control in heavy traffic, on winding roads or when the road surface is slippery. This could result in loss of vehicle control, serious injury or death.



When you are going downhill, your vehicle speed may increase above the set speed. The system will not apply the brakes. Change down a gear to assist the system in maintaining the set speed. Failure to do so could result in loss of vehicle control, serious injury or death.

**Note:** Cruise control will disengage if your vehicle speed decreases more than 10 mph (16 km/h) below your set speed while driving uphill.



E161518

The cruise controls are located on the steering wheel.

### Switching Cruise Control On

Press and release **ON**.



The indicator will display in the instrument cluster.

### Setting a Speed

1. Accelerate to the desired speed.
2. Press and release **SET ACCEL**.
3. Take your foot off the accelerator pedal.

### Changing the Set Speed

- Press and hold **SET ACCEL** to increase or **COAST** to decrease the set speed. Release the control when you reach the desired speed.
- Press and release **SET ACCEL** to increase or **COAST** to decrease. The set speed will change in approximately 1 mph (2 km/h) increments.
- Press the accelerator or brake pedal until you reach the desired speed. Press and release **SET ACCEL**.

### Canceling the Set Speed

Tap the brake pedal. The set speed will not erase.

### Resuming the Set Speed

Press and release **RES**.

### Switching Cruise Control Off

**Note:** You will erase the set speed if you switch the system off.

Press and release **OFF** or switch the ignition off.

# Load Carrying

## LOAD LIMIT

### Vehicle Loading - with and without a Trailer

This section will guide you in the proper loading of your vehicle, trailer or both, to keep your loaded vehicle weight within its design rating capability, with or without a trailer. Properly loading your vehicle will provide maximum return of vehicle design performance. Before loading your vehicle, familiarize yourself with

the following terms for determining your vehicle's weight ratings, with or without a trailer, from the vehicle's Tire Label or Safety Compliance Certification Label:

**Base Curb Weight** - is the weight of the vehicle including a full tank of fuel and all standard equipment. It does not include passengers, cargo, or optional equipment.

**Vehicle Curb Weight** - is the weight of your new vehicle when you picked it up from your authorized dealer plus any aftermarket equipment.

CARGO

=



+

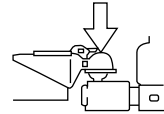

E143817

**Cargo Weight** - includes all weight added to the Base Curb Weight, including cargo and optional equipment. When towing, trailer tongue load or king pin weight is also part of cargo weight.

**GAW (Gross Axle Weight)** - is the total weight placed on each axle (front and rear) including vehicle curb weight and all payload.

**GAWR (Gross Axle Weight Rating)** - is the maximum allowable weight that can be carried by a single axle (front or rear). These numbers are shown on the Safety Compliance Certification Label. The label shall be affixed to either the door hinge

# Load Carrying

pillar, door-latch post, or the door edge that meets the door-latch post, next to the driver's seating position. **The total load on each axle must never exceed its**

## Gross Axle Weight Rating.

**Note:** For trailer towing information refer to the *RV and Trailer Towing Guide* available at an authorized dealer.

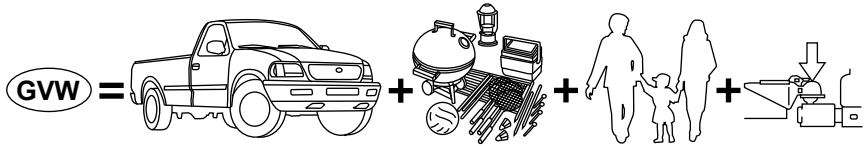

E143818

**GVW (Gross Vehicle Weight)** - is the Vehicle Curb Weight, plus cargo, plus passengers.

**GVWR (Gross Vehicle Weight Rating)** - is the maximum allowable weight of the fully loaded vehicle (including all options, equipment, passengers and cargo). It is shown on the

Safety Compliance Certification Label. The label shall be affixed to either the door hinge pillar, door-latch post, or the door edge that meets the door-latch post, next to the driver's seating position. **The Gross Vehicle Weight must never exceed the Gross Vehicle Weight Rating.**





# Load Carrying

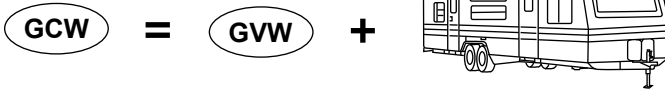

E143819

## **GCW (Gross Combined Weight)**

- is the Gross Vehicle Weight plus the weight of the fully loaded trailer.

## **GCWR (Gross Combined Weight Rating)**



- is the maximum allowable weight of the vehicle and the loaded trailer, including all cargo and passengers, that the vehicle can handle without risking damage. (Important: The towing vehicle's braking system is rated for operation at Gross Vehicle Weight Rating, not at Gross Combined Weight Rating.) Separate functional brakes should be used for safe control of towed vehicles and for trailers where the Gross Combined Weight of the towing vehicle plus the trailer exceed the Gross Vehicle Weight Rating of the towing vehicle. **The Gross Combined Weight must never exceed the Gross Combined Weight Rating.**

## **Maximum Loaded Trailer Weight**

- is the highest possible weight of a fully loaded trailer the vehicle can tow. It assumes a vehicle with mandatory options, driver and front passenger weight (150 pounds [68 kilograms] each), no cargo weight (internal

or external) and a tongue load of 10–15% (conventional trailer). Consult an authorized dealer (or the RV and Trailer Towing Guide available at an authorized dealer) for more detailed information.

## **WARNINGS**

-  Do not exceed the GVWR or the GAWR specified on the Safety Compliance Certification Label.
-  Do not use replacement tires with lower load carrying capacities than the original tires because they may lower the vehicle's GVWR and GAWR limitations. Replacement tires with a higher limit than the original tires do not increase the GVWR and GAWR limitations.
-  Exceeding any vehicle weight rating limitation could result in serious damage to the vehicle and/or personal injury.

## **Steps for determining the correct load limit:**

# Load Carrying

---

1. Locate the statement "The combined weight of occupants and cargo should never exceed XXX kg or XXX lb." on your vehicle's placard.
2. Determine the combined weight of the driver and passengers that will be riding in your vehicle.
3. Subtract the combined weight of the driver and passengers from XXX kg or XXX lb.
4. The resulting figure equals the available amount of cargo and luggage load capacity. For example, if the "XXX" amount equals 1,400 lb. and there will be five 150 lb. passengers in your vehicle, the amount of available cargo and luggage load capacity is 650 lb. ( $1400 - 750 (5 \times 150) = 650$  lb.)
5. Determine the combined weight of luggage and cargo being loaded on the vehicle. That weight may not safely exceed the available cargo and luggage load capacity calculated in Step 4.
6. If your vehicle will be towing a trailer, load from your trailer will be transferred to your vehicle. Consult this manual to determine how this reduces the available cargo and luggage load capacity of your vehicle.

The following gives you a few examples on how to calculate the available amount of cargo and luggage load capacity:

\*Suppose your vehicle has a 1400-pound (635-kilogram) cargo and luggage capacity. You decide to go golfing. Is there enough load capacity to carry you, four of your friends and all the golf bags? You and four friends average 220 pounds (99 kilograms) each and the golf bags weigh approximately 30 pounds (13.5 kilograms) each. The calculation would be:  $1400 - (5 \times 220) - (5 \times 30) = 1400 - 1100 - 150 = 150$  pounds. Yes, you have enough load capacity in your vehicle to transport four friends and your golf bags. In metric units, the calculation would be:  $635 \text{ kilograms} - (5 \times 99 \text{ kilograms}) - (5 \times 13.5 \text{ kilograms}) = 635 - 495 - 67.5 = 72.5$  kilograms.

\*Suppose your vehicle has a 1400-pound (635-kilogram) cargo and luggage capacity. You and one of your friends decide to pick up cement from the local home improvement store to finish that patio you have been planning for the past two years. Measuring the inside of the vehicle with the rear seat folded down, you have room for twelve 100-pound (45-kilogram) bags of cement. Do you have enough load capacity to transport the cement to your home? If you and your friend each weigh 220 pounds (99 kilograms), the calculation would be:  $1400 - (2 \times 220) - (12 \times 100) = 1400 - 440 - 1200 = -240$  pounds. No, you do not have enough cargo capacity to carry that much weight. In metric units, the calculation would

# Load Carrying

---

be: 635 kilograms - (2 x 99 kilograms) - (12 x 45 kilograms) = 635 - 198 - 540 = -103 kilograms. You will need to reduce the load weight by at least 240 pounds (104 kilograms). If you remove three 100-pound (45-kilogram) cement bags, then the load calculation would be: 1400 - (2 x 220) - (9 x 100) = 1400 - 440 - 900 = 60 pounds. Now you have the load capacity to transport the cement and your friend home. In metric units, the calculation would be: 635 kilograms - (2 x 99 kilograms) - (9 x 45 kilograms) = 635 - 198 - 405 = 32 kilograms.

The above calculations also assume that the loads are positioned in your vehicle in a manner that does not overload the Front or the Rear Gross Axle Weight Rating specified for your vehicle on the Safety Compliance Certification Label. The label shall be affixed to either the door hinge pillar, door-latch post, or the door edge that meets the door-latch post, next to the driver's seating position.

## Special Loading Instructions for Owners of Pick-up Trucks and Utility-type Vehicles

### WARNING

 Loaded vehicles may handle differently than unloaded vehicles. Extra precautions, such as slower speeds and increased stopping distance, should be taken when driving a heavily loaded vehicle.

---

Your vehicle can haul more cargo and people than most passenger cars. Depending upon the type and placement of the load, hauling cargo and people may raise the center of gravity of the vehicle.

# Towing

---

## TOWING A TRAILER

### WARNINGS



Do not exceed the GVWR or the GAWR specified on the certification label.



Towing trailers beyond the maximum recommended gross trailer weight exceeds the limit of the vehicle and could result in engine damage, transmission damage, structural damage, loss of vehicle control, vehicle rollover and personal injury.

---

Your vehicle may have electrical items, such as fuses or relays, related to towing. See the **Fuses** chapter.

Your vehicle's load capacity designation is by weight, not by volume, so you cannot necessarily use all available space when loading a vehicle.

Towing a trailer places an extra load on your vehicle's engine, transmission, axle, brakes, tires and suspension. Inspect these components periodically during, and after, any towing operation.

## Load Placement

To help minimize how trailer movement affects your vehicle when driving:

- Load the heaviest items closest to the trailer floor.
- Load the heaviest items centered between the left and right side trailer tires.
- Load the heaviest items above the trailer axles or just slightly forward toward the trailer tongue. Do not allow the final trailer tongue weight to go above or below 10-15% of the loaded trailer weight.
- Select a tow bar with the correct rise or drop. When both the loaded vehicle and trailer are connected, the trailer frame should be level, or slightly angled down toward your vehicle, when viewed from the side.

When driving with a trailer or payload, a slight takeoff vibration or shudder may be present due to the increased payload weight. Additional information regarding proper trailer loading and setting your vehicle up for towing is located in another chapter of this manual. See **Load Limit** (page 36). You can also find the information in the **RV & Trailer Towing Guide**, available at an authorized dealer.

# Towing

## RECOMMENDED TOWING WEIGHTS

**Note:** Do not exceed the trailer weight for your vehicle configuration listed in the chart below.

**Note:** Make sure to take into consideration trailer frontal area. Do not exceed 60 feet<sup>2</sup> (5.6 meters<sup>2</sup>) trailer frontal area.

**Note:** For high altitude operation, reduce the gross combined weight by 2% per 1000 feet (300 meters) starting at the 1000 foot (300 meter) elevation point.

**Note:** Certain states require electric trailer brakes for trailers over a specified weight. Be sure to check state regulations for this specified weight. The maximum trailer weights listed may be limited to this specified weight, as the vehicle's electrical system may not include the wiring connector needed to activate electric trailer brakes.

Your vehicle may tow a trailer provided the maximum trailer weight is less than or equal to the maximum trailer weight listed for your vehicle configuration on the following chart.

Rear axle ratio	Maximum GVWR	Maximum GCWR	Maximum trailer weight
4.30	16000 lb (7257 kg)	23000 lb (10432 kg)	7000 lb (3175 kg)
4.30	18000 lb (8165 kg)	23000 lb (10432 kg)	5000 lb (2268 kg)
4.88	19500 lb (8845 kg)	26000 lb (11793 kg)	6500 lb (2894 kg)
5.38	20500 lb (9299 kg)	26000 lb (11793 kg)	5500 lb (2500 kg)
5.38	22000 lb (9979 kg)	26000 lb (11793 kg)	4000 lb (1814 kg)
6.17	24000 lb (10886 kg)	30000 lb (13608 kg)	6000 lb (2721 kg)
6.17	26000 lb (11793 kg)	30000 lb (13608 kg)	4000 lb (1814 kg)

# Towing

## ESSENTIAL TOWING CHECKS

Follow these guidelines for safe towing:

- Do not tow a trailer until you drive your vehicle at least 1000 mi (1,600 km).
- Consult your local motor vehicle laws for towing a trailer.
- See the instructions included with towing accessories for the proper installation and adjustment specifications.
- Service your vehicle more frequently if you tow a trailer. See your scheduled maintenance information.
- If you use a rental trailer, follow the instructions the rental agency gives you.

Another chapter of this manual contains load specification terms found on the tire label and Safety Compliance label and instructions on calculating your vehicle's load. See **Load Limit** (page 36).

Remember to account for the trailer tongue weight as part of your vehicle load when calculating the total vehicle weight.

## Hitches

Do not use a hitch that either clamps onto the bumper or attaches to the axle.

Distribute the trailer load so 10-15% of the total trailer weight is on the tongue.

## Weight-Distributing Hitches

### WARNING



Do not adjust a weight-distributing hitch to any position where the rear bumper of the vehicle is higher than it was before attaching the trailer. Doing so will defeat the function of the weight-distributing hitch, which may cause unpredictable handling, and could result in serious personal injury.

When hooking-up a trailer using a weight-distributing hitch, always use the following procedure:

1. Park the loaded vehicle, without the trailer, on a level surface.
2. Measure the height to the top of your vehicle's front wheel opening on the fender. This is H1.
3. Securely attach the loaded trailer to your vehicle without the weight-distributing bars connected.
4. Measure the height to the top of your vehicle's front wheel opening on the fender a second time. This is H2.
5. Install and adjust the tension in the weight-distributing bars so that the height of your vehicle's front wheel opening on the fender is approximately halfway between H1 and H2.
6. Check that the trailer is level or slightly nose down toward your vehicle. If not, adjust the ball height accordingly and repeat Steps 1-6.
7. Lock the bar tension adjuster in place.
8. Check that the trailer tongue securely attaches and locks onto the hitch.
9. Install safety chains, lighting and trailer brake controls as required by law or the trailer manufacturer.

## Safety Chains

**Note:** *Never attach safety chains to the bumper.*

Always connect the safety chains to the hook retainers of your vehicle hitch.

To connect the safety chains, cross them under the trailer tongue and allow enough slack for turning tight corners. Do not allow the chains to drag on the ground.

# Towing

## Trailer Brakes

### WARNING



Do not connect a trailer's hydraulic brake system directly to your vehicle's brake system. Your vehicle may not have enough braking power and your chances of having a collision greatly increase.

Electric brakes and manual, automatic or surge-type trailer brakes are safe if you install them properly and adjust them to the manufacturer's specifications. The trailer brakes must meet local and federal regulations.

**The rating for the tow vehicle's braking system operation is at the gross vehicle weight rating, not the gross combined weight rating.**

**Separate functioning brake systems are required for safe control of towed vehicles and trailers weighing more than 1500 pounds (680 kilograms) when loaded.**

## Trailer Lamps

### WARNING



Never connect any trailer lamp wiring to the vehicle's tail lamp wiring; this may damage the electrical system resulting in fire. Contact your authorized dealer as soon as possible for assistance in proper trailer tow wiring installation. Additional electrical equipment may be required.

Trailer lamps are required on most towed vehicles. Make sure all running lights, brake lights, direction indicators and hazard lights are working.

## Before Towing a Trailer

Practice turning, stopping and backing up to get the feel of your vehicle-trailer combination before starting on a trip. When turning, make wider turns so the trailer wheels clear curbs and other obstacles.

## When Towing a Trailer

- Do not drive faster than 70 mph (113 km/h) during the first 500 mi (800 km).
- Do not make full-throttle starts.
- Check your hitch, electrical connections and trailer wheel lug nuts thoroughly after you have traveled 50 mi (80 km).
- When stopped in congested or heavy traffic during hot weather, place the gearshift in park (P) to aid engine and transmission cooling and to help air conditioning performance.
- Switch off the speed control with heavy loads or in hilly terrain. The speed control may turn off automatically when you are towing on long, steep grades.
- Shift to a lower gear when driving down a long or steep hill. Do not apply the brakes continuously, as they may overheat and become less effective.
- If your transmission is equipped with a Grade Assist or Tow/Haul feature, use this feature when towing. This provides engine braking and helps eliminate excessive transmission shifting for optimum fuel economy and transmission cooling.
- Allow more distance for stopping with a trailer attached. Anticipate stops and brake gradually.
- Avoid parking on a grade. However, if you must park on a grade:
  1. Turn the steering wheel to point your vehicle tires away from traffic flow.



# Towing

2. Set your vehicle parking brake.
3. Place the automatic transmission in park (P).
4. Place wheel chocks in the front and back of the trailer wheels. (Chocks not included with vehicle.)

## Launching or Retrieving a Boat or Personal Watercraft (PWC)

**Note:** Disconnect the wiring to the trailer **before** backing the trailer into the water.

**Note:** Reconnect the wiring to the trailer **after** removing the trailer from the water.

When backing down a ramp during boat launching or retrieval:

- Do not allow the static water level to rise above the bottom edge of the rear bumper.
- Do not allow waves to break higher than 6 in (15 cm) above the bottom edge of the rear bumper.

Exceeding these limits may allow water to enter vehicle components:

- Causing internal damage to the components.
- Affecting driveability, emissions and reliability.

Replace the rear axle lubricant anytime the rear axle has been submerged in water. Water may have contaminated the rear axle lubricant, which is not normally checked or changed unless a leak is suspected or other axle repair is required.

## TRANSPORTING THE VEHICLE

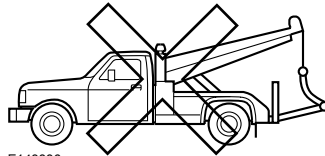
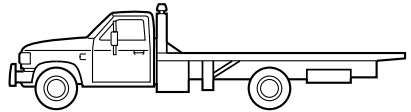
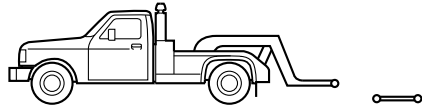

E143886

If you need to have your vehicle towed, contact a professional towing service or, if you are a member of a roadside assistance program, your roadside assistance service provider. When calling for a tow truck, let the operator know what kind of vehicle you have.

It is advisable to have your vehicle towed with a wheel lift and dollies or flatbed equipment. Do not tow with a slingbelt. Ford Motor Company has not approved a slingbelt towing procedure. Vehicle damage may occur if towed incorrectly, or by any other means.

# Towing

---

Do not exceed a maximum distance of 50 miles (80 kilometers) and maximum speed of 35 mph (56 km/h) when towing your vehicle from the front with the rear wheels on the ground. If you must exceed the maximum distance or speed, a qualified technician must remove the driveshaft. This prevents transmission damage.

## TOWING THE VEHICLE ON FOUR WHEELS

### Emergency Towing

If your vehicle becomes inoperable (without access to wheel dollies, car-hauling trailer, or flatbed transport vehicle), it can be flat-towed (all wheels on the ground, regardless of the powertrain and transmission configuration) under the following conditions:

- Your vehicle is facing forward for towing in a forward direction.
- Place the transmission in position **N**. If you cannot move the transmission into **N**, you may need to override it.
- Maximum speed is 35 mph (56 km/h).
- Maximum distance is 50 miles (80 kilometers).

# Driving Hints

---

## BREAKING-IN

You need to break in new tires for approximately 300 miles (480 kilometers). During this time, your vehicle may exhibit some unusual driving characteristics.

Avoid driving too fast during the first 1000 miles (1600 kilometers). Vary your speed frequently and change up through the gears early. Do not labor the engine.

Do not tow during the first 1000 miles (1600 kilometers).

## ECONOMICAL DRIVING

Your fuel economy is affected by several things, such as how you drive, the conditions you drive under, and how you maintain your vehicle.

You may improve your fuel economy by keeping these things in mind:

- Accelerate and slow down in a smooth, moderate fashion.
- Drive at steady speeds without stopping.
- Anticipate stops; slowing down may eliminate the need to stop.
- Combine errands and minimize stop-and-go driving.
- Close the windows for high-speed driving.
- Drive at reasonable speeds (traveling at 55 mph [88 km/h] uses 15% less fuel than traveling at 65 mph [105 km/h]).
- Keep the tires properly inflated and use only the recommended size.
- Use the recommended engine oil.
- Perform all regularly scheduled maintenance.

Avoid these actions; they reduce your fuel economy:

- Sudden accelerations or hard accelerations.
- Revving the engine before turning it off.
- Idle for periods longer than one minute.
- Warm up your vehicle on cold mornings.
- Use the air conditioner or front defroster.
- Use the speed control in hilly terrain.
- Rest your foot on the brake pedal while driving.
- Drive a heavily loaded vehicle or tow a trailer.
- Carry unnecessary weight (approximately 1 mpg [0.4 km/L] is lost for every 400 lb [180 kilogram] of weight carried).
- Driving with the wheels out of alignment.

### Conditions

- Heavily loading a vehicle or towing a trailer may reduce fuel economy at any speed.
- Adding certain accessories to your vehicle (for example bug deflectors, rollbars, light bars, running boards, ski racks or luggage racks) may reduce fuel economy.
- To maximize the fuel economy, drive with the tonneau cover installed (if equipped).
- Using fuel blended with alcohol may lower fuel economy.
- Fuel economy may decrease with lower temperatures during the first 8–10 miles (12–16 kilometers) of driving.
- Driving on flat terrain offers improved fuel economy as compared to driving on hilly terrain.

# Driving Hints

---

- Transmissions give their best fuel economy when operated in the top cruise gear and with steady pressure on the gas pedal.
- Four-wheel-drive operation (if equipped) is less fuel efficient than two-wheel-drive operation.
- Close the windows for high-speed driving.

## DRIVING THROUGH WATER

**Note:** *Driving through deep water above the recommended levels can cause vehicle damage.*

If driving through deep or standing water is unavoidable, proceed very slowly. Never drive through water that is higher than the bottom of the wheel rims (for cars) or the bottom of the hubs (for trucks).

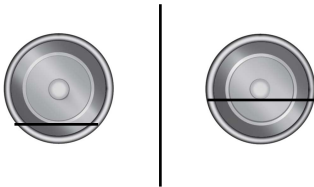

E142667

When driving through water, traction or brake capability may be limited. Also, water may enter your engine's air intake and severely damage your engine or your vehicle may stall.

Once through the water, always dry the brakes by moving your vehicle slowly while applying light pressure on the brake pedal. Wet brakes do not stop the vehicle as quickly as dry brakes.

# Roadside Emergencies

---

## ROADSIDE ASSISTANCE

### Vehicles Sold in the United States: Getting Roadside Assistance

To fully assist you should you have a vehicle concern, Ford Motor Company offers a complimentary roadside assistance program. This program is separate from the New Vehicle Limited Warranty. The service is available:

- 24 hours a day, seven days a week.
- For the coverage period listed on the Roadside Assistance Card included in your Owner's Manual portfolio.

Roadside Assistance covers:

- A flat tire change with a good spare, if provided with the vehicle (except vehicles supplied with a tire inflation kit).
- Battery jump start.
- Lock-out assistance (key replacement cost is the customer's responsibility).
- Fuel delivery — independent service contractors, if not prohibited by state, local or municipal law, shall deliver up to 2 gal (7.6 L) of gasoline or 5 gal (18.9 L) of diesel fuel to a disabled vehicle. Roadside Assistance limits fuel delivery service to two no-charge occurrences within a 12-month period.
- Winch out — available within 100 ft (30.5 m) of a paved or county maintained road, no recoveries.
- Towing — Ford eligible vehicles towed to an authorized dealer within 35 mi (56 km) of the disablement location or to the nearest authorized dealer. If a member requests a tow to an authorized dealer that is more than 35 mi (56 km) from the disablement location, the member shall be responsible for any mileage costs in excess of 35 mi (56 km).

Roadside Assistance includes up to \$200 for a towed trailer if the disabled eligible vehicle requires service at the nearest authorized dealer. If the towing vehicle is operational but the trailer is not, then the trailer does not qualify for any roadside services.

### Vehicles Sold in the United States: Using Roadside Assistance

Complete the roadside assistance identification card and place it in your wallet for quick reference. This card is in the owner's information portfolio in the glove compartment.

United States Ford vehicle customers who require Roadside Assistance, call 1-800-241-3673.

If you need to arrange roadside assistance for yourself, Ford Motor Company reimburses a reasonable amount for towing to the nearest dealership within 35 mi (56 km). To obtain reimbursement information, United States Ford vehicle customers call 1-800-241-3673. Customers need to submit their original receipts.

### Vehicles Sold in Canada: Getting Roadside Assistance

Canadian customers who require roadside assistance, call 1-800-665-2006.

### Vehicles Sold in Canada: Using Roadside Assistance

For your convenience, you may complete the roadside assistance identification card found in the centerfold of your warranty guide and retain for future reference.

# Roadside Emergencies

Canadian roadside coverage and benefits may differ from the U.S. coverage. If you require more information, please refer to the coverage section of your warranty guide, call us in Canada at 1-800-665-2006, or visit our website at [www.ford.ca](http://www.ford.ca).

Sykes Assistance Services Corporation administers the Roadside Assistance program. You must receive covered services in Canada or the continental United States. Coverage extends to vehicles that use public, non-seasonal, annually traveled roadways. Roadside Assistance coverage does not extend to vehicles involved in cross-country driving, logging, autocross and any other form of off-road use. Well maintained roads and surfaces help ensure safe travel for the supplier, and allow their representatives to perform service as per the standard operating procedures.

## In Remote Locations

If our supplier cannot take your vehicle by road to the nearest authorized dealership, transportation by rail or water may be necessary. The program covers a tow to the dock or rail terminal and also to the dealership at the end of the trip.

For rail or water transportation, however, contact your authorized dealer to confirm if you are eligible for additional coverage before you authorize or pay for the service.

Call the Ford Roadside Assistance at 1-800-665-2006 for additional information.

## HAZARD WARNING FLASHERS

**Note:** *The hazard warning flashers will operate when the ignition is in any position or if the key is not in the ignition. If used when the engine is not running, the battery will lose charge. As a result, there may be insufficient power to restart your engine.*

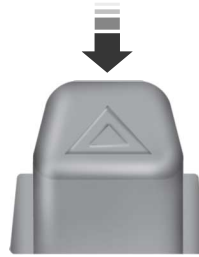



E161463

The hazard flasher control is located on the steering column, just behind the steering wheel. Use it when your vehicle is creating a safety hazard for other motorists.

- Press the flasher control and all front and rear direction indicators flash.
- Press the flasher control again to turn them off.

## JUMP STARTING THE VEHICLE

### WARNINGS

-  The gases around the battery can explode if exposed to flames, sparks, or lit cigarettes. An explosion could result in personal injury or vehicle damage.
-  Batteries contain sulfuric acid which can burn skin, eyes and clothing, if contacted.
-  Use only an adequate-sized cable with insulated clamps.

# Roadside Emergencies

## Preparing Your Vehicle

**Note:** Do not attempt to push-start your automatic transmission vehicle. Automatic transmissions do not have push-start capability. Attempting to push-start a vehicle with an automatic transmission may cause transmission damage.

**Note:** Use only a 12-volt supply to start your vehicle.

**Note:** Do not disconnect the battery of the disabled vehicle as this could damage the vehicle's electrical system.

Park the booster vehicle close to the hood of the disabled vehicle, making sure the two vehicles do not touch. Turn all accessories off.

## Connecting the Jumper Cables

### WARNING



Do not attach the cables to fuel lines, engine rocker covers, the intake manifold or electrical components as grounding points. Stay clear of moving parts. To avoid reverse polarity connections, make sure that you correctly identify the positive (+) and negative (-) terminals on both the disabled and booster vehicles before connecting the cables.

**Note:** In the illustration, the bottom vehicle represents the booster vehicle.

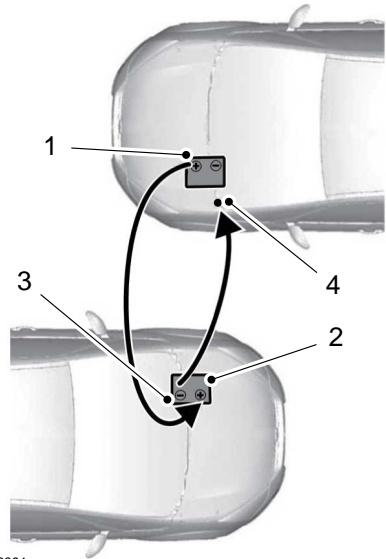

E142664

1. Connect the positive (+) jumper cable to the positive (+) terminal of the discharged battery.
2. Connect the other end of the positive (+) cable to the positive (+) terminal of the assisting battery.
3. Connect the negative (-) cable to the negative (-) terminal of the assisting battery.
4. Make the final connection of the negative (-) cable to an exposed metal part of the stalled vehicle's engine, or connect the negative (-) cable to a ground connection point if available.

### WARNING



Do not connect the end of the second cable to the negative (-) terminal of the battery to be jumped. A spark may cause an explosion of the gases that surround the battery.

# Roadside Emergencies

## Jump Starting

1. Start the engine of the booster vehicle and rev the engine moderately, or press the accelerator gently to keep your engine speed between 2000 and 3000 rpm, as shown in your tachometer.
  2. Start the engine of the disabled vehicle.
  3. Once the disabled vehicle has been started, run both vehicle engines for an additional three minutes before disconnecting the jumper cables.
2. Remove the jumper cable on the negative (-) terminal of the booster vehicle's battery.
  3. Remove the jumper cable from the positive (+) terminal of the booster vehicle's battery.
  4. Remove the jumper cable from the positive (+) terminal of the disabled vehicle's battery.

After the disabled vehicle has been started and the jumper cables removed, allow it to idle for several minutes so the battery can recharge.

## Removing the Jumper Cables

Remove the jumper cables in the reverse order that they were connected.

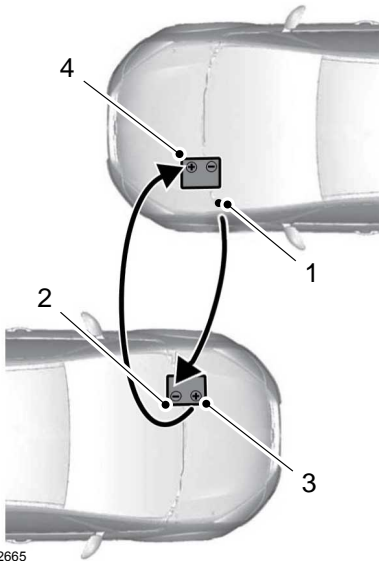

1. Remove the jumper cable from the ground metal surface or connecting point, if available.



# Customer Assistance

---

## GETTING THE SERVICES YOU NEED

Warranty repairs to your vehicle must be performed by an authorized dealer. While any authorized dealer handling your vehicle line will provide warranty service, we recommend you return to your selling authorized dealer who wants to ensure your continued satisfaction.

Please note that certain warranty repairs require special training and equipment, so not all authorized dealers are authorized to perform all warranty repairs. This means that, depending on the warranty repair needed, you may have to take your vehicle to another authorized dealer.

A reasonable time must be allowed to perform a repair after taking your vehicle to the authorized dealer. Repairs will be made using Ford or Motorcraft® parts, or remanufactured or other parts that are authorized by Ford.

### Away From Home

If you are away from home when your vehicle needs service, contact the Ford Customer Relationship Center or use the online resources listed below to find the nearest authorized dealer.

In the United States:

#### Mailing address

Ford Motor Company  
Customer Relationship Center  
P.O. Box 6248  
Dearborn, MI 48121

#### Telephone

1-800-392-3673 (FORD)  
(TDD for the hearing impaired:  
1-800-232-5952)

#### Online

Additional information and resources are available online at [www.fordowner.com](http://www.fordowner.com)

These are some of the items that can be found online:

- U.S. dealer locator by Dealer Name, City/State or Zip Code.
- Owner Manuals.
- Maintenance Schedules.
- Recalls.
- Ford Extended Service Plans.
- Ford Genuine Accessories.
- Service specials and promotions.

In Canada:

#### Mailing address

Customer Relationship Centre  
Ford Motor Company of Canada, Limited  
P.O. Box 2000  
Oakville, Ontario L6K 0C8

#### Telephone

1-800-565-3673 (FORD)

#### Online

[www.ford.ca](http://www.ford.ca)

#### Twitter

@FordServiceCA (English Canada)  
@FordServiceQC (Quebec)

#### Additional Assistance

If you have questions or concerns, or are unsatisfied with the service you are receiving, follow these steps:

1. Contact your Sales Representative or Service Advisor at your selling/servicing authorized dealer.
2. If your inquiry or concern remains unresolved, contact the Sales Manager, Service Manager or Customer Relations Manager.
3. If you require assistance or clarification on Ford Motor Company policies, please contact the Ford Customer Relationship Center.

# Customer Assistance

---

In order to help us serve you better, please have the following information available when contacting a Customer Relationship Center:

- Vehicle Identification Number.
- Your telephone number (home and business).
- The name of the authorized dealer and city where located.
- The vehicle's current odometer reading.

In some states, you must directly notify Ford in writing before pursuing remedies under your state's warranty laws. Ford is also allowed a final repair attempt in some states.

In the United States, a warranty dispute must be submitted to the BBB AUTO LINE before taking action under the Magnuson-Moss Warranty Act, or to the extent allowed by state law, before pursuing replacement or repurchase remedies provided by certain state laws. This dispute handling procedure is not required prior to enforcing state created rights or other rights which are independent of the Magnuson-Moss Warranty Act or state replacement or repurchase laws.

## **IN CALIFORNIA (U.S. ONLY)**

California Civil Code Section 1793.2(d) requires that, if a manufacturer or its representative is unable to repair a motor vehicle to conform to the vehicle's applicable express warranty after a reasonable number of attempts, the manufacturer shall be required to either replace the vehicle with one substantially identical or repurchase the vehicle and reimburse the buyer in an amount equal to the actual price paid or payable by the consumer (less a reasonable allowance for consumer use). The consumer has the right to choose whether to receive a refund or replacement vehicle.

California Civil Code Section 1793.22(b) presumes that the manufacturer has had a reasonable number of attempts to conform the vehicle to its applicable express warranties if, within the first 18 months of ownership of a new vehicle or the first 18000 miles (29 000 km), whichever occurs first:

1. Two or more repair attempts are made on the same non-conformity likely to cause death or serious bodily injury OR
2. Four or more repair attempts are made on the same nonconformity (a defect or condition that substantially impairs the use, value or safety of the vehicle) OR
3. The vehicle is out of service for repair of nonconformities for a total of more than 30 calendar days (not necessarily all at one time).

In the case of 1 or 2 above, the consumer must also notify the manufacturer of the need for the repair of the nonconformity at the following address:

Ford Motor Company  
16800 Executive Plaza Drive  
Mail Drop 3NE-B  
Dearborn, MI 48126

You are required to submit your warranty dispute to BBB AUTO LINE before asserting in court any rights or remedies conferred by California Civil Code Section 1793.22(b). You are also required to use BBB AUTO LINE before exercising rights or seeking remedies created by the Federal Magnuson-Moss Warranty Act, 15 U.S.C. sec. 2301 et seq. If you choose to seek redress by pursuing rights and remedies not created by California Civil Code Section 1793.22(b) or the Magnuson-Moss Warranty Act, resort to BBB AUTO LINE is not required by those statutes.

## Customer Assistance

---

### THE BETTER BUSINESS BUREAU (BBB) AUTO LINE PROGRAM (U.S. ONLY)

Your satisfaction is important to Ford Motor Company and to your dealer. If a warranty concern has not been resolved using the three-step procedure outlined earlier in this chapter in the Getting the Services you need section, you may be eligible to participate in the BBB AUTO LINE program.

The BBB AUTO LINE program consists of two parts – mediation and arbitration. During mediation, a representative of the BBB will contact both you and Ford Motor Company to explore options for settlement of the claim. If an agreement is not reached during mediation or you do not want to participate in mediation, and if your claim is eligible, you may participate in the arbitration process. An arbitration hearing will be scheduled so that you can present your case in an informal setting before an impartial person. The arbitrator will consider the testimony provided and make a decision after the hearing.

Disputes submitted to the BBB AUTO LINE program are usually decided within forty days after you file your claim with the BBB. You are not bound by the decision, and may reject the decision and proceed to court where all findings of the BBB Auto Line dispute, and decision, are admissible in the court action. Should you choose to accept the BBB AUTO LINE decision, Ford is then bound by the decision, and must comply with the decision within 30 days of receipt of your acceptance letter.

**BBB AUTO LINE Application:** Using the information provided below, please call or write to request a program application. You will be asked for your name and address, general information about your new vehicle, information about your warranty concerns, and any steps you have

already taken to try to resolve them. A Customer Claim Form will be mailed that will need to be completed, signed and returned to the BBB along with proof of ownership. Upon receipt, the BBB will review the claim for eligibility under the Program Summary Guidelines.

**You can get more information by calling BBB AUTO LINE at 1-800-955-5100, or writing to:**

**BBB AUTO LINE  
3033 Wilson Boulevard, Suite 600  
Arlington, Virginia 22201**

BBB AUTO LINE applications can also be requested by calling the Ford Motor Company Customer Relationship Center at 1-800-392-3673.

**Note:** *Ford Motor Company reserves the right to change eligibility limitations, modify procedures, or to discontinue this process at any time without notice and without obligation.*

### UTILIZING THE MEDIATION/ARBITRATION PROGRAM (CANADA ONLY)

For vehicles delivered to authorized Canadian dealers. In those cases where you continue to feel that the efforts by Ford of Canada and the authorized dealer to resolve a factory-related vehicle service concern have been unsatisfactory, Ford of Canada participates in an impartial third party mediation/arbitration program administered by the Canadian Motor Vehicle Arbitration Plan (CAMVAP).

The CAMVAP program is a straight forward and relatively speedy alternative to resolve a disagreement when all other efforts to produce a settlement have failed. This procedure is without cost to you and is designed to eliminate the need for lengthy and expensive legal proceedings.

# Customer Assistance

---

In the CAMVAP program, impartial third-party arbitrators conduct hearings at mutually convenient times and places in an informal environment. These impartial arbitrators review the positions of the parties, make decisions and, when appropriate, render awards to resolve disputes. CAMVAP decisions are fast, fair, and final as the arbitrator's award is binding on both you and Ford of Canada.

CAMVAP services are available in all Canadian territories and provinces. For more information, without charge or obligation, call your CAMVAP Provincial Administrator directly at 1-800-207-0685 or visit [www.camvap.ca](http://www.camvap.ca).

## GETTING ASSISTANCE OUTSIDE THE U.S. AND CANADA

Before exporting your vehicle to a foreign country, contact the appropriate foreign embassy or consulate. These officials can inform you of local vehicle registration regulations and where to find unleaded fuel.

If you cannot find unleaded fuel or can only get fuel with an anti-knock index lower than is recommended for your vehicle, contact our Customer Relationship Center.

The use of leaded fuel in your vehicle without proper conversion may damage the effectiveness of your emission control system and may cause engine knocking or serious engine damage. Ford Motor Company or Ford of Canada is not responsible for any damage caused by use of improper fuel. Using leaded fuel may also result in difficulty importing your vehicle back into the United States.

If your vehicle must be serviced while you are traveling or living in Asia-Pacific Region, Sub-Saharan Africa, U.S. Virgin Islands, Central America, the Caribbean, and Israel, contact the nearest authorized dealer. If the authorized dealer cannot help you, contact:

FORD MOTOR COMPANY  
Customer Relationship Center  
1555 Fairlane Drive  
Fairlane Business Park #3  
Allen Park, Michigan 48101  
U.S.A.  
Telephone: (313) 594-4857  
Fax: (313) 390-0804  
Email: [expcac@ford.com](mailto:expcac@ford.com)

For customers in Guam, the Commonwealth of the Northern Mariana Islands (CNMI), America Samoa, and the U.S. Virgin Islands, please feel free to call our Toll-Free Number: (800) 841-FORD (3673).

If your vehicle must be serviced while you are traveling or living in Puerto Rico, contact the nearest authorized dealer. If the authorized dealer cannot help you, contact:

FORD MOTOR COMPANY  
Customer Relationship Center  
1555 Fairlane Drive  
Fairlane Business Park #3  
Allen Park, Michigan 48101  
U.S.A.  
Telephone: (800) 841-FORD (3673)  
FAX: (313) 390-0804  
Email: [prcac@ford.com](mailto:prcac@ford.com)  
[www.ford.com.pr](http://www.ford.com.pr)

If your vehicle must be serviced while you are traveling or living in the Middle East, contact the nearest authorized dealer. If the authorized dealer cannot help you, contact:

# Customer Assistance

FORD MOTOR COMPANY  
Customer Relationship Center  
1555 Fairlane Drive  
Fairlane Business Park #3  
Allen Park, Michigan 48101  
U.S.A.  
Telephone: +971 4 3326084  
Toll-Free Number of the Kingdom of Saudi  
Arabia: 800 8971409  
Local Telephone Number of Kuwait:  
24810575  
FAX: +971 4 3327299  
Email: [menacac@ford.com](mailto:menacac@ford.com)  
[www.me.ford.com](http://www.me.ford.com)

If you buy your vehicle in North America and then relocate to any of the above locations, register your vehicle identification number (VIN) and new address with Ford Motor Company Export Operations & Global Growth Initiatives by emailing [expcac@ford.com](mailto:expcac@ford.com).

If you are in another foreign country, contact the nearest authorized dealer. In the event your inquiry is unresolved, communicate your concern with the dealership's Sales Manager, Service Manager or Customer Relations Manager. If you require additional assistance or clarification, please contact the respective Customer Relationship Center as previously listed.

**Customers in the U.S. should call  
1-800-392-3673.**

## ORDERING ADDITIONAL OWNER'S LITERATURE

To order the publications in this portfolio, contact Helm, Incorporated at:

HELM, INCORPORATED  
47911 Halyard Drive  
Plymouth, Michigan 48170  
Attention: Customer Service

Or to order a free publication catalog, call toll free: 1-800-782-4356

Monday-Friday 8:00 a.m. - 6:00 p.m. EST  
Helm, Incorporated can also be reached by their website:

[www.helminc.com](http://www.helminc.com)

(Items in this catalog may be purchased by credit card, check or money order.)

## Obtaining a French Owner's Manual

French Owner's Manual can be obtained from your authorized dealer or by contacting Helm, Incorporated using the contact information listed previously in this section.

## REPORTING SAFETY DEFECTS (U.S. ONLY)



E142557

If you believe that your vehicle has a defect which could cause a crash or could cause injury or death, you should immediately inform the National Highway Traffic Safety Administration (NHTSA) in addition to notifying Ford Motor Company.

If NHTSA receives similar complaints, it may open an investigation, and if it finds that a safety defect exists in a group of vehicles, it may order a recall and remedy campaign. However, NHTSA cannot become involved in individual problems between you, your dealer, or Ford Motor Company.

## Customer Assistance

---

To contact NHTSA, you may call the Vehicle Safety Hotline toll-free at 1-888-327-4236 (TTY: 1-800-424-9153); go to <http://www.safercar.gov>; or write to:

Administrator

1200 New Jersey Avenue,  
Southeast

Washington, D.C. 20590

You can also obtain other information about motor vehicle safety from <http://www.safercar.gov>.

### **REPORTING SAFETY DEFECTS (CANADA ONLY)**

If you believe that your vehicle has a defect which could cause a crash or could cause injury or death, you should immediately inform Transport Canada.

<b>Transport Canada Contact Information</b>	
Website	<a href="http://www.tc.gc.ca/eng/roadsafety/menu.htm">http://www.tc.gc.ca/eng/roadsafety/menu.htm</a>
Phone	1-800-333-0510

# Fuses

## FUSE SPECIFICATION CHART

### Power Distribution Box

#### WARNINGS



Always disconnect the battery before servicing high current fuses.



To reduce risk of electrical shock, always replace the cover to the power distribution box before reconnecting the battery or refilling fluid reservoirs.

Locate the power distribution box in the engine compartment. It has high-current fuses that protect your vehicle's main electrical systems from overloads.

If the battery has been disconnected and reconnected, you will need to reset some features. See **Changing the 12V Battery** (page 83).

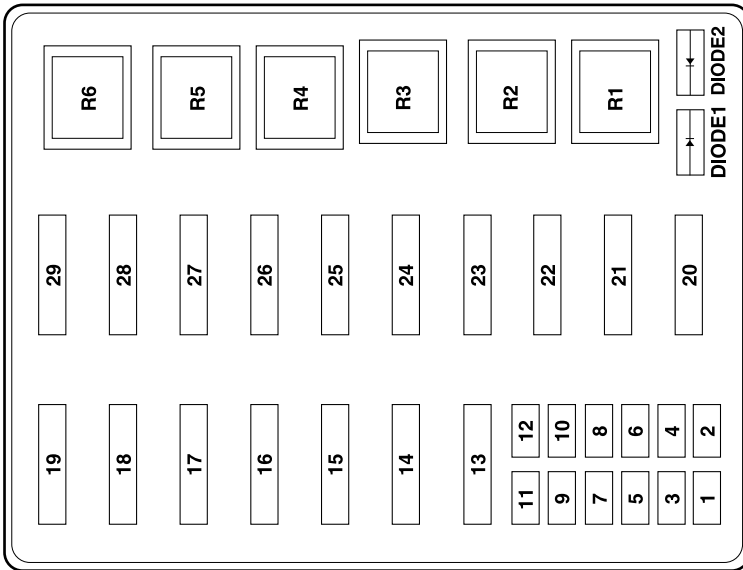

E161519

Fuse or relay number	Fuse amp rating	Protected components
1	5A*	Power brake assist module – Hydromax.
2	10A*	Air conditioning compressor clutch.
3	20A*	Air conditioning clutch relay coil. Catalyst monitor sensor.

## Fuses

<b>Fuse or relay number</b>	<b>Fuse amp rating</b>	<b>Protected components</b>
		Engine heated exhaust gas oxygen sensor #11 and #21. Mass air flow sensor with intake air temperature. Vapor management valve.
4	5A*	Powertrain control module memory. Powertrain control module relay coil.
5	20A*	Powertrain control module power.
6	20A*	Instrument panel dimmer module. Instrument panel fuse #41. Park lamp feeds. Trailer tow running lamp relay coil.
7	20A*	Ignition coils. Radio capacitors.
8	30A*	Hydromax – Anti-lock brake system module.
9	10A*	Powertrain control module. Starter ground relay coil. Starter main relay coil.
10	20A*	Daytime running lamps.
11	20A*	Fuel pump relay coil. Powertrain control module power.
12	25A*	Instrument panel - backup lamp feed. Trailer tow back-up lamps feed.
13	30A**	Trailer tow electric brake controller feed.
14	60A**	Instrument panel battery feed (fuse #9, 15, 21). Lighting primary fuse.
15	20A**	Trailer tow park lamps.
16	60A**	Anti-lock brake system module – Hydromax.
	40A**	Anti-lock brake system module – Hydroboost.
17	20A**	Horn feed.



## Fuses

Fuse or relay number	Fuse amp rating	Protected components
18	20A**	Backup lamp feed. Tow/haul switch. Transmission control indicator light.
19	—	Not used.
20	30A**	Powertrain control module relay coil. Powertrain control module relay (Power distribution box fuses # 3, 5, 7, 18).
21	20A**	Fuel injectors. Fuel pump motor.
22	20A**	Cigar lighter feed. Diagnostic tool connector.
23	40A**	Blower motor feed.
24	50A**	Instrument panel battery feed (fuses #4, 10, 16, 22).
25	40A**	Ignition switch feed (Instrument panel fuses #1, 5, 7, 11, 13, 14, 17, 19, 23; Power distribution box fuses #9, 11).
26	40A**	Ignition switch feed (Instrument panel fuses #5, 11, 17, 23, 26, 38).
27	30A**	Multi-function switch (headlamps).
28	30A**	Starter solenoid.
29	60A**	Power brake assist motor – Hydromax.
	40A**	Anti-lock brake system module – Hydroboost.
R1	—	Air conditioning clutch relay.
R2	—	Fuel pump relay.
R3	—	Horn relay.
R4	—	Starter relay.
R5	—	Blower motor relay.
R6	—	Powertrain control module relay.

# Fuses

Fuse or relay number	Fuse amp rating	Protected components
Diode 1	—	Fuel pump diode.
Diode 2	—	Air conditioning clutch diode.

\*Mini fuses.

\*\*Maxi fuses.

## UPS Power Distribution Box 1

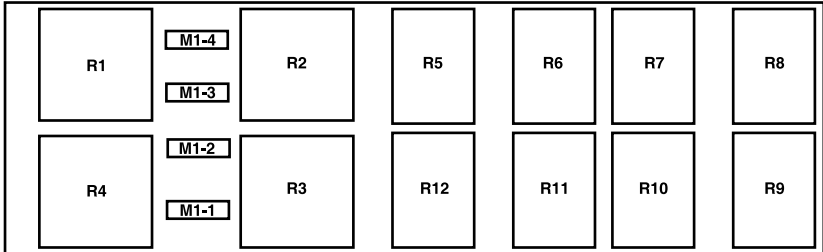

E172543

Fuse or relay number	Fuse amp rating	Protected components
R1	Relay	Powertrain control module.
R2	Relay	Daytime running lamps.
R3	Relay	Starter motor.
R4	Relay	Blower motor.
R5	Relay	Horn.
R6	Relay	Fuel pump.
R7	Relay	Starter ground.
R8	Relay	Trailer tow parking lamps.
R9	Relay	Back-up lamps.
R10	Relay	Not used.
R11	Relay	Not used.
R12	Relay	Air conditioning.

# Fuses

Fuse or relay number	Fuse amp rating	Protected components
M1-1	10A	Hydromax brake on/off relay.
M1-2	—	Not used.
M1-3	—	Not used.
M1-4	—	Not used.

## UPS Power Distribution Box 2

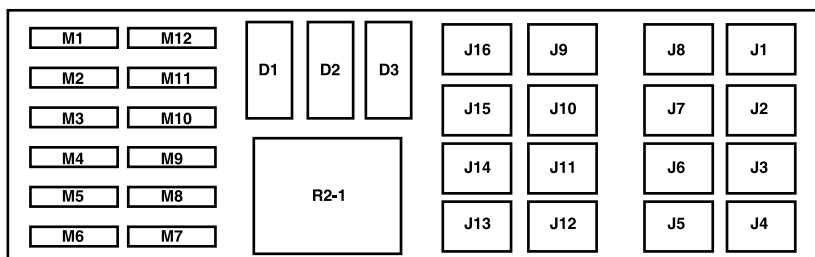

E172544

Fuse or relay number	Fuse amp rating	Protected components
M1	25A*	Back-up lamps.
M2	20A*	Daytime running lamps.
M3	30A*	4-channel anti-lock brake system module (Hydromax).
M4	20A*	Powertrain control module run/start. Fuel pump relay coil.
M5	10A*	Starter relay coil.
M6	20A*	Vehicle power 4.
M7	5A*	Hydromax motor monitor.
M8	20A*	Vehicle power 2.
M9	20A*	Vehicle power 1.
M10	10A*	Air conditioning.

## Fuses

<b>Fuse or relay number</b>	<b>Fuse amp rating</b>	<b>Protected components</b>
M11	5A*	Powertrain control module relay keep alive power.
M12	20A*	Parking lamps.
D1	Diode	One-touch start.
D2	Diode	Fuel pump.
D3	Diode	Air conditioning.
R2-1	—	Not used.
J1	30A**	Powertrain control module vehicle power.
J2	20A**	Fuel pump.
J3	20A**	Cigar lighter power point. Diagnostic connector.
J4	40A**	Blower motor.
J5	30A**	Headlamps.
J6	40A**	Ignition switch feeds.
J7	40A**	Ignition switch feeds.
J8	50A**	Instrument panel fuse box.
J9	30A**	Starter motor solenoid.
J10	40A**	3-channel anti-lock brake system module.
	60A**	4-channel anti-lock brake system module (Hydromax).
J11	30A**	Trailer tow electronic brake.
J12	60A**	Lighting.
J13	20A**	Vehicle power 3.
J14	20A**	Horn.
J15	40A**	3-channel anti-lock brake system module.

# Fuses

Fuse or relay number	Fuse amp rating	Protected components
	60A**	4-channel anti-lock brake system module.
J16	20A**	Trailer tow parking lamps.

\*Mini fuse.

\*\*J-case fuse.

## Diode and Relay Module

Locate the module box with the power distribution box in front of the radiator.

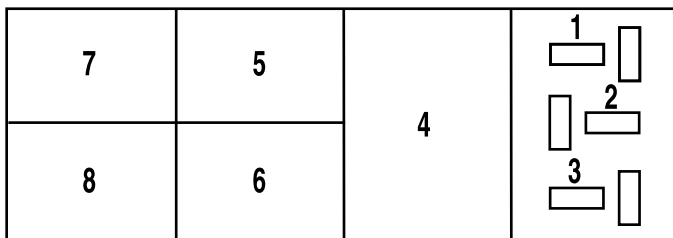

E161520

Relay location	Protected components
1	One-touch integrated start (ATO diode).
2	Not used.
3	Not used.
4	Daytime running lamps power relay.
5	Hydromax – brake on/off signal isolating relay.
6	Reverse lamps relay.
7	Starter ground relay.
8	Trailer tow parking lamps relay.

# Fuses

## Fuse Holder Module

Locate the fuse holder next to the diode and relay module.

Fuse number	Fuse amp rating	Protected components
1	10A	Hydromax – brake on/off signal.

## Passenger Compartment Fuse Panel

To remove a fuse, use the fuse panel cover's fuse puller tool.

Locate this fuse panel below and to the left of the steering wheel near the brake pedal. Remove the panel cover to access the fuses.

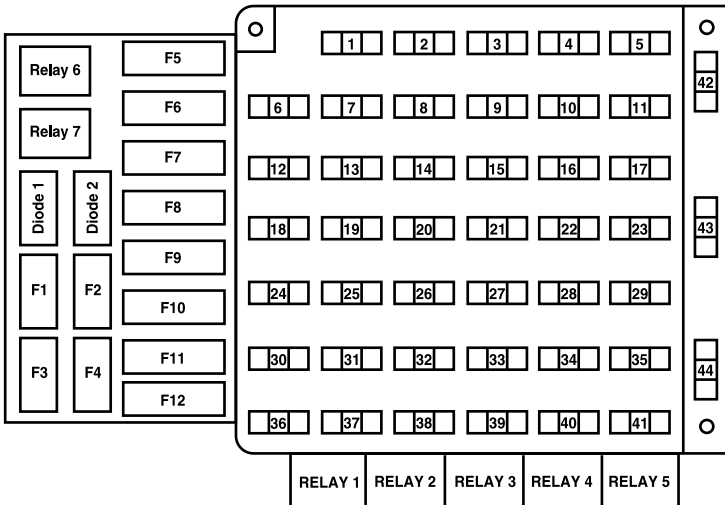

E161521

Fuse or relay number	Fuse amp rating	Protected components
1	20A	Body builder rear direction indicator and stop lamp feeds. Direction indicators.

## Fuses

Fuse or relay number	Fuse amp rating	Protected components
		Direction indicators and stop lamps.
2	—	Not used.
3	—	Not used.
4	10A	Instrument cluster.
5	10A	Body builder accessory feed (accessory and run).
6	—	Not used.
7	15A	Blower motor relay coil.
8	10A	Brake lamps feed.
9	20A	Stop lamps; Vehicle direction indicators and stop lamps, Body builder rear direction indicators and stop feeds, Body builder stop lamp feed.
10	10A	Instrument cluster memory.
11	30A	Wiper/washer module. Wiper feed.
12	—	Not used.
13	10A	Anti-lock brake system module – Hydromax.
14	10A	Anti-lock brake system module – Hydro-boost. Instrument cluster power. Instrument cluster warning lamps. Warning indicator module.
15	15A	Left-hand direction indicator feed.
16	20A	Body builder battery (+12V) feed.
17	5A	Body builder radio feed.
18	—	Not used.
19	5A	Daytime running lamps relays.
20	—	Not used.
21	15A	Right-hand direction indicator feed.

# Fuses

Fuse or relay number	Fuse amp rating	Protected components
22	20A	Trailer tow direction indicators.
23	10A	Cluster run/accessory.
24	—	Not used.
25	10A	Body builder right-hand low beam head-lamp feed.
26	10A	Brake shift interlock actuator.
27	—	Not used.
28	—	Not used.
29	—	Not used.
30	—	Not used.
31	10A	Body builder left-hand low beam head-lamp feed.
32	—	Not used.
33	10A	Reverse lamps.
34	10A	Body builder reverse gear. Trailer tow reverse lamps.
35	20A	Body builder high beam feed. High beam indicator.
36	—	Not used.
37	—	Not used.
38	10A	Body builder run feed.
39	—	Not used.
40	—	Not used.
41	10A	Instrument cluster lighting.
42	—	Not used.
43	—	Not used.
44	—	Not used.
Relay 1	—	Trailer tow right-hand direction indicator.



# Fuses

Fuse or relay number	Fuse amp rating	Protected components
Relay 2	—	Trailer tow left-hand direction indicator.
Relay 3	—	Right-hand direction indicator.
Relay 4	—	Left-hand direction indicator.
Relay 5	—	Not used.
Relay 6	—	Daytime running lamps. Parking brake.
Relay 7	—	Daytime running lamps on/off.
Diode 1	—	Brake transmission shift interlock.
Diode 2	—	Brake transmission shift interlock.
F1	—	Not used.
F2	—	Not used.
F3	—	Not used.
F4	10A	Brake transmission shift interlock.
F5	—	Not used.
F6	—	Not used.
F7	—	Not used.
F8	—	Not used.
F9	—	Not used.
F10	—	Not used.
F11	—	Not used.
F12	—	Not used.

# Fuses

## CHANGING A FUSE

### Fuses

#### WARNING



Always replace a fuse with one that has the specified amperage rating. Using a fuse with a higher amperage rating can cause severe wire damage and could start a fire.

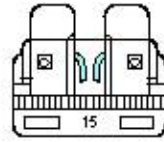

E142430

If electrical components in the vehicle are not working, a fuse may have blown. Blown fuses are identified by a broken wire within the fuse. Check the appropriate fuses before replacing any electrical components.

### Standard Fuse Amperage Rating and Color

Color					
Fuse rating	Mini fuses	Standard fuses	Maxi fuses	Cartridge maxi fuses	Fuse link cartridge
2A	Grey	Grey	-	-	-
3A	Violet	Violet	-	-	-
4A	Pink	Pink	-	-	-
5A	Tan	Tan	-	-	-
7.5A	Brown	Brown	-	-	-
10A	Red	Red	-	-	-
15A	Blue	Blue	-	-	-
20A	Yellow	Yellow	Yellow	Blue	Blue
25A	Natural	Natural	-	Natural	Natural
30A	Green	Green	Green	Pink	Pink
40A	-	-	Orange	Green	Green
50A	-	-	Red	Red	Red
60A	-	-	Blue	Yellow	Yellow
70A	-	-	Tan	-	Brown
80A	-	-	Natural	Black	Black

# Maintenance

---

## GENERAL INFORMATION

Have your vehicle serviced regularly to help maintain its roadworthiness and resale value. There is a large network of Ford authorized dealers that are there to help you with their professional servicing expertise. We believe that their specially trained technicians are best qualified to service your vehicle properly and expertly. They are supported by a wide range of highly specialized tools developed specifically for servicing your vehicle.

To help you service your vehicle, we provide scheduled maintenance information which makes tracking routine service easy. See **Scheduled Maintenance** (page 121).

If your vehicle requires professional service, your authorized dealer can provide the necessary parts and service. Check your warranty information to find out which parts and services are covered.

Use only recommended fuels, lubricants, fluids and service parts conforming to specifications. Motorcraft® parts are designed and built to provide the best performance in your vehicle.

## Precautions

- Do not work on a hot engine.
- Make sure that nothing gets caught in moving parts.

- Do not work on a vehicle with the engine running in an enclosed space, unless you are sure you have enough ventilation.
- Keep all open flames and other burning material (such as cigarettes) away from the battery and all fuel related parts.

## Working with the Engine Off

1. Set the parking brake and shift to **P** (Park).
2. Turn off the engine and remove the key (if equipped).
3. Block the wheels.

## Working with the Engine On

### WARNING



To reduce the risk of vehicle damage and/or personal burn injuries, do not start your engine with the air cleaner removed and do not remove it while the engine is running.

---

1. Set the parking brake and shift to **P** (Park).
2. Block the wheels

# Maintenance

## UNDER HOOD OVERVIEW

### Motorhome chassis

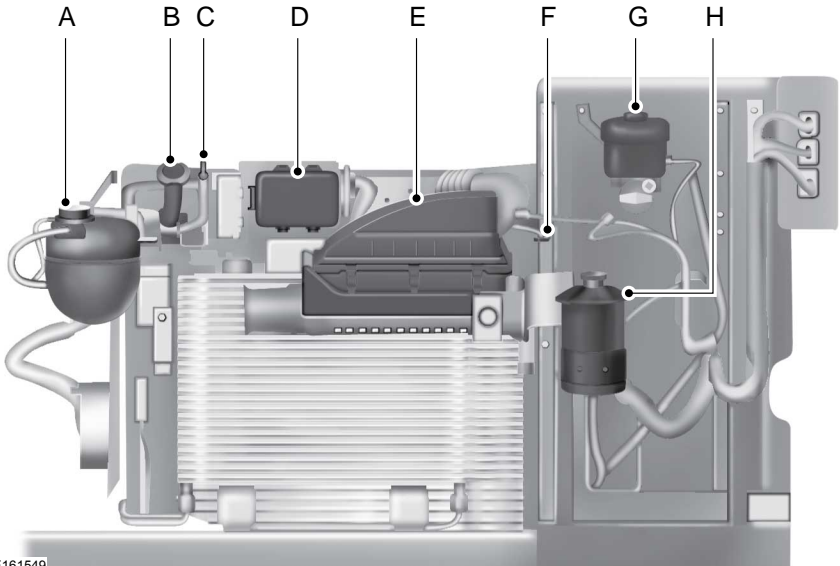

E161549

- A. Engine coolant reservoir
- B. Engine oil filler cap
- C. Automatic transmission fluid dipstick
- D. Power distribution box
- E. Air filter assembly
- F. Engine oil dipstick
- G. Brake fluid reservoir
- H. Power steering fluid reservoir

# Maintenance

## Commercial chassis

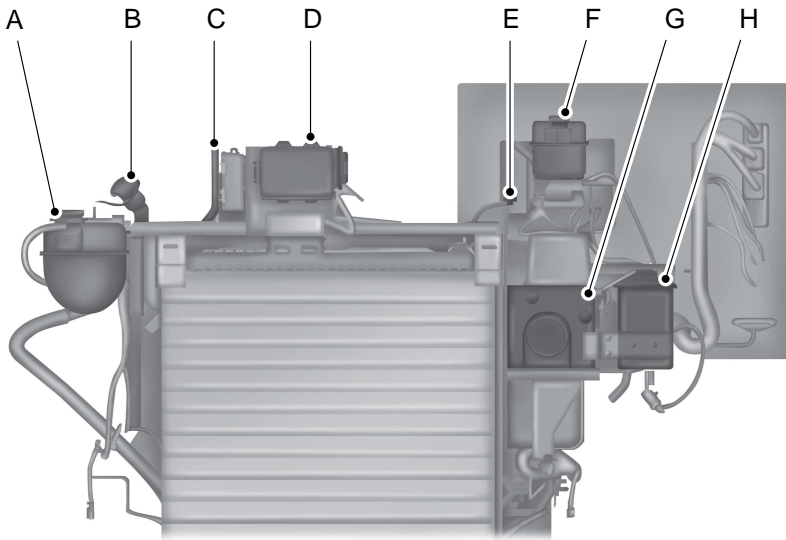

E161550

- A. Engine coolant reservoir
- B. Engine oil filler cap
- C. Automatic transmission fluid dipstick
- D. Power distribution box
- E. Engine oil dipstick
- F. Brake fluid reservoir
- G. Air filter assembly
- H. Power steering fluid reservoir

# Maintenance

## ENGINE OIL DIPSTICK

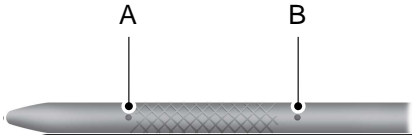

E161560

- A MIN
- B MAX

## ENGINE OIL CHECK

**Note:** Check the level before starting the engine.

**Note:** Make sure that the level is between the MIN and the MAX marks.

1. Make sure that your vehicle is on level ground.
2. Turn the engine off and wait 10 minutes for the oil to drain into the oil pan.
3. Remove the dipstick and wipe it with a clean, lint-free cloth. Replace the dipstick and remove it again to check the oil level.

If the level is at the MIN mark, add oil immediately.

### Adding Engine Oil

**Note:** Do not remove the filler cap when the engine is running.

**Note:** Do not add oil further than the MAX mark. Oil levels above the MAX mark may cause engine damage.



E142732

Only use oils certified for gasoline engines by the American Petroleum Institute (API). An oil with this trademark symbol conforms to the current engine and emission system protection standards and fuel economy requirements of the International Lubricants Specification Advisory Council (ILSAC), comprised of U.S. and Japanese automobile manufacturers.

1. Remove the filler cap.
2. Add engine oil that meets the Ford specifications. See **Capacities and Specifications** (page 111).
3. Replace the filler cap. Turn it until you feel a strong resistance.

### Resetting the Oil Life Monitoring System

**Note:** Reset the oil life monitoring only after an oil change.

1. Turn the ignition key to the ON position. Do not start the engine. For vehicles with push-button start, press and hold the start button for two seconds without pressing the brake pedal. Do not attempt to start the engine.
2. Press both the accelerator and brake pedals at the same time.
3. Keep both pedals fully pressed.

# Maintenance

---

4. After three seconds, the Service: Oil reset in prog. message will be displayed.
5. After 25 seconds, the Service: Oil reset complete message will be displayed.
6. Release the accelerator and brake pedals, then rotate the key to the off position.

**Note:** *The Service: Oil reset complete message will no longer be displayed.*

## ENGINE COOLANT CHECK

### WARNINGS



Do not add engine coolant when the engine is hot. Steam and scalding liquids released from a hot cooling system can burn you badly. Also, spilling coolant on hot engine parts can burn you.



Do not put engine coolant in the windshield washer fluid container. If sprayed on the windshield, engine coolant could make it difficult to see through the windshield.



To reduce the risk of personal injury, make sure the engine is cool before unscrewing the coolant pressure relief cap. The cooling system is under pressure; steam and hot liquid can come out forcefully when you loosen the cap slightly.



Do not add coolant further than the MAX mark.

---

When the engine is cold, check the concentration and level of the engine coolant at the intervals listed in the scheduled maintenance information. See **Scheduled Maintenance** (page 121).

**Note:** *Make sure that the level is between the MIN and MAX marks on the coolant reservoir.*

**Note:** *Coolant expands when it is hot. The level may extend beyond the MAX mark*

**Note:** *If the level is at the MIN mark, below the MIN mark, or empty, add coolant immediately. See **Adding Engine Coolant** in this chapter.*

The coolant concentration should be maintained within 48% to 50%, which equates to a freeze point between -30°F (-34°C) and -34°F (-37°C).

**Note:** *For best results, coolant concentration should be tested with a refractometer such as Robinair Coolant and Battery Refractometer 75240. We do not recommend the use of hydrometers or coolant test strips for measuring coolant concentrations.*

**Note:** *Automotive fluids are not interchangeable. Do not use engine coolant, antifreeze or windshield washer fluid outside of its specified function and vehicle location.*

## Adding Engine Coolant

**Note:** *Do not use stop leak pellets, cooling system sealants, or additives as they can cause damage to the engine cooling or heating systems. Your vehicle's warranty does not cover this damage.*

# Maintenance

---

- Do not mix different colors or types of coolant in your vehicle. Make sure the correct coolant is used. Mixing of engine coolants may harm the engine's cooling system. The use of an improper coolant may harm the engine and cooling system components and may void the warranty. Use prediluted engine coolant meeting the Ford specification. See **Capacities and Specifications** (page 111).
- In case of emergency, you can add a large amount of water without engine coolant in order to reach a vehicle service location. In this instance, you must have the cooling system drained, chemically cleaned with Motorcraft Premium Cooling System Flush, and refilled with engine coolant as soon as possible. Water alone (without engine coolant) can cause engine damage from corrosion, overheating or freezing.
- Do not use alcohol, methanol, brine or any engine coolants mixed with alcohol or methanol antifreeze (coolant). Alcohol and other liquids can cause engine damage from overheating or freezing.
- Do not add extra inhibitors or additives to the coolant. These can be harmful and compromise the corrosion protection of the engine coolant.

Unscrew the cap slowly. Any pressure will escape as you unscrew the cap.

Add prediluted engine coolant meeting the Ford specification. See **Capacities and Specifications** (page 111).

Whenever you add coolant, check the coolant level in the coolant reservoir the next few times you drive the vehicle. If necessary, add enough prediluted engine coolant to bring the coolant level to the proper level.

## Recycled Engine Coolant

Ford Motor Company does not recommend the use of recycled engine coolant since a Ford-approved recycling process is not yet available.

Used engine coolant should be disposed of in an appropriate manner. Follow your community's regulations and standards for recycling and disposing of automotive fluids.

## Severe Climates

If you drive in extremely cold climates:

- It may be necessary to have a Ford authorized dealer increase the coolant concentration above 50%.
- A coolant concentration of 60% will provide improved freeze point protection. Engine coolant concentrations above 60% will decrease the overheat protection characteristics of the engine coolant and may cause engine damage

If you drive in extremely hot climates:

- It may be necessary to have a Ford authorized dealer decrease the coolant concentration to 40%.
- A coolant concentration of 40% will provide improved overheat protection. Engine coolant concentrations below 40% will decrease the freeze and corrosion protection characteristics of the engine coolant and may cause engine damage.

Vehicles driven year-round in non-extreme climates should use prediluted engine coolant for optimum cooling system and engine protection.



# Maintenance

## What you Should Know About Fail-Safe Cooling

If you deplete the engine coolant supply, this feature allows you to drive your vehicle temporarily before you incur incremental component damage. The fail-safe distance depends on ambient temperatures, vehicle load and terrain.

### How Fail-Safe Cooling Works

If the engine begins to overheat, the engine coolant temperature gauge will move to the red (hot) area and:



The coolant temperature warning indicator will light.



The service engine soon indicator will light.

If the engine reaches a preset over-temperature condition, the engine will automatically switch to alternating cylinder operation. Each disabled cylinder acts as an air pump and cools the engine.

When this occurs, the vehicle will still operate. However:

- The engine power will be limited.
- This will disable the air conditioning system.

Continued operation will increase the engine temperature and the engine will completely shut down, causing steering and braking effort to increase.

Once the engine temperature cools, the engine can be re-started. Take your vehicle to an authorized dealer as soon as possible to minimize engine damage.

## When Fail-Safe Mode Is Activated

### WARNINGS



Fail-safe mode is for use during emergencies only. Operate the vehicle in fail-safe mode only as long as necessary to bring the vehicle to rest in a safe location and seek immediate repairs. When in fail-safe mode, the vehicle will have limited power, will not be able to maintain high-speed operation and may completely shut down without warning, potentially losing engine power, power steering assist and power brake assist, which may increase the possibility of a crash resulting in serious injury.



Never remove the coolant reservoir cap while the engine is running or hot.

You have limited engine power when in the fail-safe mode, so drive the vehicle with caution. The vehicle will not be able to maintain high-speed operation and the engine will run rough. Remember that the engine is capable of completely shutting down automatically to prevent engine damage, therefore:

1. Pull off the road as soon as safely possible and switch off the engine.
2. Have your vehicle towed to an authorized dealer.
3. If this is not possible, wait a short period for the engine to cool.
4. Check the coolant level and replenish if low.
5. Re-start the engine and take your vehicle to an authorized dealer.

**Note:** *Driving the vehicle without repairing the engine problem increases the chance of engine damage. Take your vehicle to an authorized dealer as soon as possible.*

# Maintenance

## AUTOMATIC TRANSMISSION FLUID CHECK

### WARNING



The dipstick cap and surrounding components may be hot; gloves are recommended.

**Note:** *Automatic transmission fluid expands when warmed. To obtain an accurate fluid check, drive the vehicle until it is at normal operating temperature (approximately 20 miles [30 km]). If your vehicle has been operated for an extended period at high speeds, in city traffic during hot weather or pulling a trailer, the vehicle should be turned off for about 30 minutes to allow fluid to cool to normal operating temperature 150°F - 170°F (66°C - 77°C) before checking.*

Refer to your scheduled maintenance information for scheduled intervals for fluid checks and changes.

Your transmission does not consume fluid. However, the fluid level should be checked if the transmission is not working properly, (i.e., if the transmission slips or shifts slowly) or if you notice some sign of fluid leakage. To check the fluid level:

1. Drive the vehicle 20 miles (30 km) or until it reaches normal operating temperature
2. Park the vehicle on a level surface and engage the parking brake
3. With the engine running, parking brake engaged and your foot on the brake pedal, move the gearshift lever through all of the gear ranges. Allow sufficient time for each gear to engage
4. Latch the gearshift lever in P (Park) and leave the engine running.
5. Remove the dipstick, wiping it clean with a clean, dry lint free rag. If necessary, refer to Under Hood Overview in this chapter for the location of the dipstick.
6. Install the dipstick making sure it is fully seated in the filler tube.
7. Remove the dipstick and inspect the fluid level. The fluid should be in the designated area for normal operating temperature or ambient temperature.

Do not use supplemental transmission fluid additives, treatments or cleaning agents. The use of these materials may affect transmission operation and result in damage to internal transmission components.

### Low fluid level



E161551

Do not drive the vehicle if there is no indication of fluid on the dipstick and the ambient temperature is above 50°F (10°C).

### Correct fluid level



E161552

# Maintenance

The transmission fluid should be in this range if at normal operating temperature (150°F-170°F [66°C-77°C]).

The transmission fluid should be checked at normal operating temperature 150°F-170°F (66°C-77°C) on a level surface. The normal operating temperature can be reached after approximately 20 miles (30 km) of driving. You can check the fluid without driving if the ambient temperature is above 50°F (10°C). However, if fluid is added at this time, an overfill condition could result when the vehicle reaches normal operating temperature

## High fluid level



E161553

Fluid levels above the safe range may result in transmission failure. An overfill condition of transmission fluid may cause shift and/or engagement concerns and/or possible damage. High fluid levels can be caused by an overheating condition.

## Adjusting automatic transmission fluid levels

**Note:** Use of a non-approved automatic transmission fluid may cause internal transmission damage. Before adding any fluid, make sure the correct type is used. The type of fluid used is normally indicated on the transmission dipstick and also in the See **Capacities and Specifications** (page 111).



E161554

Add fluid in ½ pint (250 ml) increments through the filler tube until the level is correct.

**Note:** If an overfill occurs, excess fluid should be removed by an authorized dealer. An overfill condition of transmission fluid may cause shift and/or engagement concerns and/or possible damage.

Do not use supplemental transmission fluid additives, treatments or cleaning agents. The use of these materials may affect transmission operation and result in damage to internal transmission components.

## Automatic transmission fluid filter

The TorqShift™ automatic transmission is equipped with a serviceable transmission fluid filter located inside the transmission bottom pan. Refer to the scheduled maintenance information for service intervals for the automatic transmission fluid and transmission filter. For transmission filter maintenance, see your authorized dealer.

## BRAKE FLUID CHECK

Fluid levels between the MIN and MAX lines are within the normal operating range; there is no need to add fluid. If the fluid levels are outside of the normal operating range, the performance of the system could be compromised; seek service from your authorized dealer immediately.

# Maintenance

## Hydromax

### WARNINGS



Carefully read cautionary information on product label. For MEDICAL EMERGENCY INFORMATION contact a physician or Poison Control Center immediately; on Ford-Motorcraft™ products call: 1-800-959-3673 (FORD). Failure to follow these instructions may result in personal injury.



Use of any brake fluid other than that indicated for your brake system will cause permanent damage.



Do not let the reservoir for the master cylinder run dry. This may cause the brakes to fail and result in personal injury.

Chassis with gross vehicle weight ratings of 20500 pounds (9299 kilograms), 22000 pounds (9979 kilograms), 24000 pounds (10886 kilograms) and 26000 pounds (11793 kilograms) are equipped with Hydromax Brake Booster Systems and must use Motorcraft DOT 5.1 Motor Vehicle Brake Fluid or equivalent meeting Ford Specification ESD-M6C57-A. See **Technical Specifications** (page 115).

Add fluid up to the bottom of the rings located at the top of the reservoir. Do not fill above this line.



E161555

- Use only DOT 5.1 brake fluid that is certified to meet Ford specifications.
- A clear gel-like substance in the hydraulic brake master cylinder reservoir may appear on some vehicles. This substance is a silicone base lubricant used during assembly of the master cylinder. It will float on top of the brake hydraulic fluid in the master cylinder. This condition is normal and in no way affects the operation of the brake system. It does not require any service.
- Brake system fluid should be replaced on a regular basis to maintain optimum braking performance, especially under heavy-duty driving conditions such as frequent steep grades or heavy towing loads. See **Scheduled Maintenance** (page 121).

## Hydroboost

Chassis with gross vehicle weight ratings of 16000 pounds (7257 kilograms), 18000 pounds (8165 kilograms) and 19500 pounds (8845 kilograms) are equipped with Hydroboost Brake Booster Systems and must use Motorcraft High Performance DOT 3 Motor Vehicle Brake Fluid or equivalent meeting Ford Specification WSS-M6C62-A.

Add brake fluid from a clean unopened container until the level reaches MAX. Do not fill above this line. Use only DOT 3 brake fluid that is certified to meet Ford specifications.

Brake system fluid should be replaced on a regular basis to maintain optimum braking performance, especially under heavy-duty driving conditions such as frequent steep grades or heavy towing loads. See **Scheduled Maintenance** (page 121).

# Maintenance

## Parking brake fluid

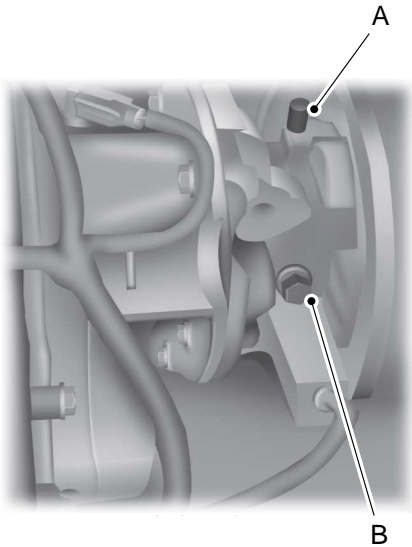

E161556

**Note:** Do not fill the parking brake through the vent plug (A) (located on top of the transmission).

Check the parking brake fluid level only if there is visible signs of fluid leakage. If necessary, fill the parking brake assembly to the bottom of the filler plug hole (B) (located on the driver side of the transmission). See **Technical Specifications** (page 115).

## POWER STEERING FLUID CHECK

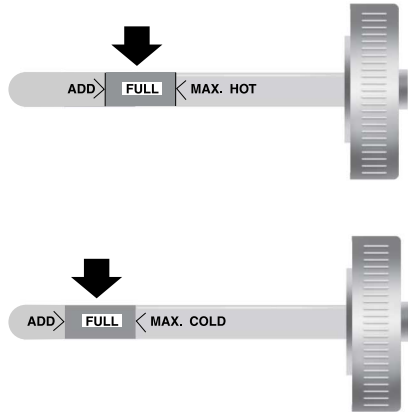

E161557

**Note:** The power steering cap has both a cold and hot indicator on the dipstick.

1. Start the engine and let it run until it reaches normal operating temperature (the engine coolant temperature gauge indicator will be near the center of the normal area between H and C).
2. While the engine idles, turn the steering wheel left and right several times.
3. Turn the engine off.

# Maintenance

4. Check the fluid level on the dipstick. It should be between the arrows in the FULL range on the side of the dipstick with the words MAX. HOT at the top. Do not add fluid if the level is within this range.
5. If the fluid is low, add fluid in small amounts, continuously checking the level until it reaches the FULL range. Be sure to put the dipstick back in the reservoir.

## Steering linkage lubrication points

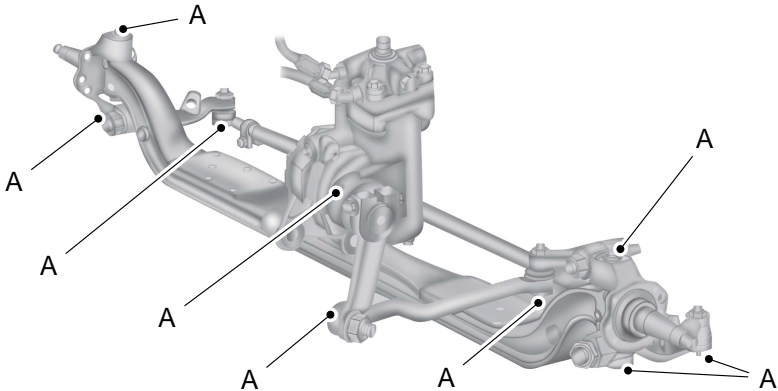

E161558

There are nine lubrication points on the steering linkage shown as "A". See **Technical Specifications** (page 115).

## FUEL FILTER

Your vehicle is equipped with a lifetime fuel filter that is integrated with the fuel tank. Regular maintenance or replacement is not needed.

## CHANGING THE 12V BATTERY

### WARNINGS

 Batteries normally produce explosive gases which can cause personal injury. Therefore, do not allow flames, sparks or lighted substances to come near the battery. When working near the battery, always shield your face and protect your eyes. Always provide proper ventilation.

 When lifting a plastic-cased battery, excessive pressure on the end walls could cause acid to flow through the vent caps, resulting in personal injury and damage to the vehicle or battery. Lift the battery with a battery carrier or with your hands on opposite corners.

# Maintenance

## WARNINGS



Keep batteries out of reach of children. Batteries contain sulfuric acid. Avoid contact with skin, eyes or clothing. Shield your eyes when working near the battery to protect against possible splashing of acid solution. In case of acid contact with skin or eyes, flush immediately with water for a minimum of 15 minutes and get prompt medical attention. If acid is swallowed, call a physician immediately.

**Note:** *If your battery has a cover/shield, make sure it is reinstalled after the battery has been cleaned or replaced.*

**Note:** *Battery posts, terminals and related accessories contain lead and lead compounds. Wash hands after handling.*

Your vehicle is equipped with a Motorcraft® maintenance-free battery which normally does not require additional water during its life of service.

For longer, trouble-free operation, keep the top of the battery clean and dry. Also, make certain the battery cables are always tightly fastened to the battery terminals.

If you see any corrosion on the battery or terminals, remove the cables from the terminals and clean with a wire brush. You can neutralize the acid with a solution of baking soda and water.

It is recommended that the negative battery cable terminal be disconnected from the battery if you plan to store your vehicle for an extended period of time.

To ensure proper operation of the battery management system (BMS), any electrical devices that are added to the vehicle should not have their ground connection made directly at the negative battery post. A connection at the negative battery post can cause inaccurate measurements of the battery condition and potential incorrect system operation.

**Note:** *Electrical or electronic accessories or components added to the vehicle by the dealer or the owner may adversely affect battery performance and durability and may also affect the performance of other electrical systems in the vehicle.*

When a battery replacement is required, the battery should only be replaced with a Ford recommended replacement battery that matches the electrical requirements of the vehicle.

**Note:** *Always dispose of automotive batteries in a responsible manner. Follow your local authorized standards for disposal. Call your local authorized recycling center to find out more about recycling automotive batteries.*

## Battery relearn

When the battery is disconnected or a new battery installed:

# Maintenance

- The transmission must relearn its adaptive strategy. As a result of this, the transmission may shift firmly. This operation is considered normal and will not affect function or durability of the transmission. Over time the adaptive learning process will fully update transmission operation to its optimum shift feel.
- The clock and the preset radio stations must be reset once the battery is reconnected.
- Your vehicle's engine is electronically controlled by a computer, some control conditions are maintained by power from the battery, the engine must relearn its idle and fuel trim strategy.

When the battery is disconnected or a new battery is installed, begin the battery relearn process:

1. With the vehicle at a complete stop, set the parking brake.
2. Put the gearshift lever in **P** (Park), turn off all accessories and start the engine.
3. Run the engine until it reaches normal operating temperature.
4. Allow the engine to idle for at least one minute.
5. Turn the A/C on and allow the engine to idle for at least one minute.
6. Drive the vehicle to complete the relearning process.
  - The vehicle may need to be driven to relearn the idle and fuel trim strategy.

## CHANGING THE ENGINE AIR FILTER

### WARNING



To reduce the risk of vehicle damage and personal burn injuries, do not start your engine with the air cleaner removed and do not remove it while the engine is running.

Change the air filter element at the proper interval. See **Scheduled Maintenance** (page 121).

When changing the air filter element, use only the air filter element listed. See **Capacities and Specifications** (page 111).

**Note:** *Failure to use the correct air filter element may result in severe engine damage. The customer warranty may be void for any damage to the engine if the correct air filter element is not used.*

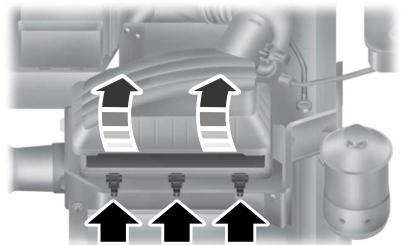

E161559

1. Loosen the latches that secure the air filter cover in place.
2. Carefully separate the two halves of the air filter housing.
3. Remove the air filter element from the housing.
4. Wipe any dirt or debris from the air filter housing and cover.



# Maintenance

---

5. Install a new air filter element.
6. Replace the air filter cover to the housing and secure the latches. Be careful not to crimp the filter element edges between the air filter housing. This could cause filter damage and allow unmetered air to enter the engine if not properly seated.

# Vehicle Care

---

## GENERAL INFORMATION

Your Ford or Lincoln authorized dealer has many quality products available to clean your vehicle and protect its finishes.

## CLEANING THE EXTERIOR

Wash your vehicle regularly with cool or lukewarm water and a neutral pH shampoo, such as Motorcraft Detail Wash.

- Never use strong household detergents or soap, such as dish washing or laundry liquid. These products can discolor and spot painted surfaces.
- Never wash a vehicle that is “hot to the touch” or during exposure to strong, direct sunlight.
- Dry your vehicle with a chamois or soft terry cloth towel in order to eliminate water spotting.
- Immediately remove items such as gasoline, diesel fuel, bird droppings and insect deposits because they can cause damage to your vehicle’s paintwork and trim over time. Use Motorcraft Bug and Tar Remover.
- Remove any exterior accessories, such as antennas, before entering a car wash.

**Note:** *Suntan lotions and insect repellents can damage any painted surface; if these substances come in contact with your vehicle, wash off as soon as possible.*

### Stripes or Graphics (if equipped)

Do not use a commercial or high-pressure sprayer on the surface or edge of stripes and graphics. This can cause damage to the film and cause the edge of the film to peel away from the vehicle surface.

## Exterior Chrome

**Note:** *Never use abrasive materials such as steel wool or plastic pads as they can scratch the chrome surface.*

**Note:** *Do not use chrome cleaner, metal cleaner or polish on wheels and wheel covers*

- Wash your vehicle first, using cool or lukewarm water and a neutral pH shampoo, such as Motorcraft Detail Wash.
- Use Motorcraft Custom Bright Metal Cleaner. Apply the product as you would a wax to clean bumpers and other chrome parts; allow the cleaner to dry for a few minutes, then wipe off the haze with a clean, dry rag.
- Do not apply cleaning product to hot surfaces and do not leave cleaning product on chrome surfaces longer than the time recommended.
- Using other non-recommended cleaners can result in severe and permanent cosmetic damage.

## Underbody

Flush the complete underside of your vehicle frequently. Keep body and door drain holes free from packed dirt.

## Cleaning Plastic Exterior Parts

Use only approved products to clean plastic parts

- For routine cleaning, use Motorcraft Detail Wash.
- If tar or grease spots are present, use Motorcraft Bug and Tar Remover.

## CLEANING THE ENGINE

Engines are more efficient when they are clean because grease and dirt buildup keep the engine warmer than normal.

# Vehicle Care

---

When washing:

- Take care when using a power washer to clean the engine. The high-pressure fluid could penetrate the sealed parts and cause damage.
- Do not spray a hot engine with cold water to avoid cracking the engine block or other engine components.
- Spray Motorcraft Engine Shampoo and Degreaser on all parts that require cleaning and pressure rinse clean. In Canada, use Motorcraft Engine Shampoo.
- Never wash or rinse the engine while it is hot or running; water in the running engine may cause internal damage.
- Never wash or rinse any ignition coil, spark plug wire or spark plug well, or the area in and around these locations.
- Cover the battery, power distribution box, and air filter assembly to prevent water damage when cleaning the engine.

## CLEANING THE ALLOY WHEELS (If Equipped)

**Note:** Do not apply a cleaning chemical to warm or hot wheel rims and covers.

**Note:** Some automatic car washes may cause damage to the finish on your wheel rims and covers.

**Note:** Industrial-strength or heavy-duty cleaners in combination with brush agitation to remove brake dust and dirt, could wear away the clear coat finish over a period time.

**Note:** Do not use hydrofluoric acid-based or high caustic-based wheel cleaners, steel wool, fuels or strong household detergents.

**Note:** If you intend parking your vehicle for an extended period after cleaning the wheels with a wheel cleaner, drive your vehicle for a few minutes before doing so. This will reduce the risk of increased corrosion of the brake discs.

Alloy wheels and wheel covers are coated with a clear coat paint finish. To maintain their condition we recommend that you:

- Clean the wheels weekly using Motorcraft Wheel and Tire Cleaner. Apply using manufacturer's instructions.
- Use a sponge to remove heavy deposits of dirt and brake dust accumulation.
- Rinse thoroughly with a strong stream of water when you have completed the cleaning process.
- To remove tar and grease, use Motorcraft Bug and Tar Remover.

## VEHICLE STORAGE

If you plan on storing your vehicle for 30 days or more, read the following maintenance recommendations to make sure your vehicle stays in good operating condition.

We engineer and test all motor vehicles and their components for reliable, regular driving. Under various conditions, long-term storage may lead to degraded engine performance or failure unless you use specific precautions to preserve engine components.

### General

- Store all vehicles in a dry, ventilated place.
- Protect from sunlight, if possible.
- If vehicles are stored outside, they require regular maintenance to protect against rust and damage.

# Vehicle Care

---

## Body

- Wash your vehicle thoroughly to remove dirt, grease, oil, tar or mud from exterior surfaces, rear-wheel housing and the underside of front fenders.
- Periodically wash your vehicle if it is stored in exposed locations.
- Touch-up exposed or primed metal to prevent rust.
- Cover chrome and stainless steel parts with a thick coat of auto wax to prevent discoloration. Re-wax as necessary when you wash your vehicle.
- Lubricate all hood, door and trunk lid hinges, and latches with a light grade oil.
- Cover interior trim to prevent fading.
- Keep all rubber parts free from oil and solvents.

## Engine

- The engine oil and filter should be changed prior to storage because used engine oil contains contaminants that may cause engine damage.
- Start the engine every 15 days for a minimum of 15 minutes. Run at fast idle with the climate controls set to defrost until the engine reaches normal operating temperature.
- With your foot on the brake, shift through all the gears while the engine is running.
- We recommend that you change the engine oil before you use your vehicle again.

## Fuel system

- Fill the fuel tank with high-quality fuel until the first automatic shutoff of the fuel pump nozzle.

## Cooling system

- Protect against freezing temperatures.
- When removing your vehicle from storage, check coolant fluid level. Confirm that there are no cooling system leaks and that fluid is at the recommended level.

## Battery

- Check and recharge as necessary. Keep connections clean.
- If storing your vehicle for more than 30 days without recharging the battery, we recommend that you disconnect the battery cables to maintain battery charge for quick starting.

**Note:** *It is necessary to reset memory features if battery cables are disconnected.*

## Brakes

- Make sure the brakes and parking brake release fully.

## Tires

- Maintain recommended air pressure.

## Miscellaneous

- Make sure all linkages, cables, levers and pins under your vehicle are covered with grease to prevent rust.
- Move vehicles at least 25 ft (7.5 m) every 15 days to lubricate working parts and prevent corrosion.

## Removing Vehicle From Storage

When your vehicle is ready to come out of storage, do the following:

- Wash your vehicle to remove any dirt or grease film build-up on window surfaces.
- Check windshield wipers for any deterioration.

# Vehicle Care

---

- Check under the hood for any foreign material that may have collected during storage such as mice or squirrel nests.
- Check the exhaust for any foreign material that may have collected during storage.
- Check tire pressures and set tire inflation per the Tire Label.
- Check brake pedal operation. Drive your vehicle 15 ft (4.5 m) back and forth to remove rust build-up.
- Check fluid levels (including coolant, oil and gas) to make sure there are no leaks, and fluids are at recommended levels.
- If you remove the battery, clean the battery cable ends and inspect.

Contact an authorized dealer if you have any concerns or issues.

# Wheels and Tires

## TIRE CARE

### Information About Uniform Tire Quality Grading



E142542

Tire Quality Grades apply to new pneumatic passenger car tires. The Quality grades can be found where applicable on the tire sidewall between tread shoulder and maximum section width. For example: **Treadwear 200 Traction AA Temperature A.**

These Tire Quality Grades are determined by standards that the United States Department of Transportation has set.

Tire Quality Grades apply to new pneumatic passenger car tires. They do not apply to deep tread, winter-type snow tires, space-saver or temporary use spare tires, light truck or LT type tires, tires with nominal rim diameters of 10 to 12 inches or limited production tires as defined in Title 49 Code of Federal Regulations Part 575.104 (c)(2).

### U.S. Department of Transportation Tire quality grades:

The U.S. Department of Transportation requires Ford Motor Company to give you the following information about tire grades exactly as the government has written it.

#### Treadwear

The treadwear grade is a comparative rating based on the wear rate of the tire when tested under controlled conditions on a specified government test course. For example, a tire graded 150 would wear 1 ½ times as well on the government course as a tire graded 100. The relative performance of tires depends upon the actual conditions of their use, however, and may depart significantly from the norm due to variations in driving habits, service practices, and differences in road characteristics and climate.

#### Traction AA A B C

#### WARNING

 The traction grade assigned to this tire is based on straight-ahead braking traction tests, and does not include acceleration, cornering, hydroplaning or peak traction characteristics.

# Wheels and Tires

---

The traction grades, from highest to lowest are AA, A, B, and C. The grades represent the tire's ability to stop on wet pavement as measured under controlled conditions on specified government test surfaces of asphalt and concrete. A tire marked C may have poor traction performance.

## Temperature A B C

### WARNING



The temperature grade for this tire is established for a tire that is properly inflated and not overloaded. Excessive speed, underinflation, or excessive loading, either separately or in combination, can cause heat buildup and possible tire failure.

The temperature grades are A (the highest), B and C, representing the tire's resistance to the generation of heat and its ability to dissipate heat when tested under controlled conditions on a specified indoor laboratory test wheel. Sustained high temperature can cause the material of the tire to degenerate and reduce tire life, and excessive temperature can lead to sudden tire failure. The grade C corresponds to a level of performance which all passenger car tires must meet under the

Federal Motor Vehicle Safety Standard No. 139. Grades B and A represent higher levels of performance on the laboratory test wheel than the minimum required by law.

## Glossary of Tire Terminology

\***Tire label:** A label showing the original equipment tire sizes, recommended inflation pressure and the maximum weight the vehicle can carry.

\***Tire Identification Number:** A number on the sidewall of each tire providing information about the tire brand and manufacturing plant, tire size and date of manufacture. Also referred to as DOT code.

\***Inflation pressure:** A measure of the amount of air in a tire.

\***Standard load:** A class of P-metric or Metric tires designed to carry a maximum load at set pressure. For example: For P-metric tires 35 psi (2.4 bar) or 36 (2.5 bar) depending on tire size and for Metric tires 36 psi (2.5 bar). Increasing the inflation pressure beyond this pressure will not increase the tire's load carrying capability.

\***Extra load:** A class of P-metric or Metric tires designed to carry a heavier maximum load at 42 psi (2.9 bar). Increasing the inflation pressure beyond this pressure will not increase the tire's load carrying capability.

# Wheels and Tires

\***kPa:** Kilopascal, a metric unit of air pressure.

\***PSI:** Pounds per square inch, a standard unit of air pressure.

\***Cold tire pressure:** The tire pressure when the vehicle has been stationary and out of direct sunlight for an hour or more and prior to the vehicle being driven for 1 mile (1.6 kilometers).

\***Recommended inflation pressure:** The cold inflation pressure found on the Safety Compliance Certification Label. See the completed vehicle's owner's manual for the location of the Safety Compliance Certification Label.

\***Bead area of the tire:** Area of the tire next to the rim.

\***Sidewall of the tire:** Area between the bead area and the tread.

\***Tread area of the tire:** Area of the perimeter of the tire that contacts the road when mounted on the vehicle.

\***Rim:** The metal support (wheel) for a tire or a tire and tube assembly upon which the tire beads are seated.

## Information Contained on the Tire Sidewall

Both United States and Canada Federal regulations require tire manufacturers to place standardized information on the sidewall of all tires. This information identifies and describes the fundamental characteristics of the tire and also provides a U.S. DOT Tire Identification Number for safety standard certification and in case of a recall.

## Information on P Type Tires

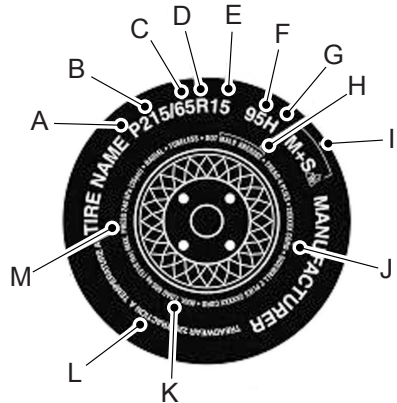

E142543

P215/65R15 95H is an example of a tire size, load index and speed rating. The definitions of these items are listed below. (Note that the tire size, load index and speed rating for your vehicle may be different from this example.)



# Wheels and Tires

A. **P:** Indicates a tire, designated by the Tire and Rim Association, that may be used for service on cars, sport utility vehicles, minivans and light trucks. **Note:** If your tire size does not begin with a letter this may mean it is designated by either the European Tire and Rim Technical Organization or the Japan Tire Manufacturing Association.

B. **215:** Indicates the nominal width of the tire in millimeters from sidewall edge to sidewall edge. In general, the larger the number, the wider the tire.

C. **65:** Indicates the aspect ratio which gives the tire's ratio of height to width.

D. **R:** Indicates a radial type tire.

E. **15:** Indicates the wheel or rim diameter in inches. If you change your wheel size, you will have to purchase new tires to match the new wheel diameter.

F. **95:** Indicates the tire's load index. It is an index that relates to how much weight a tire can carry. You may find this information in your owner's manual. If not, contact a local tire dealer.

**Note:** *You may not find this information on all tires because it is not required by federal law.*

G. **H:** Indicates the tire's speed rating. The speed rating denotes the speed at which a tire is designed to be driven for extended periods of time under a standard condition of load and inflation pressure. The tires on your vehicle may operate at different conditions for load and inflation pressure. These speed ratings may need to be adjusted for the difference in conditions. The ratings range from 81 mph (130 km/h) to 186 mph (299 km/h). These ratings are listed in the following chart.

**Note:** *You may not find this information on all tires because it is not required by federal law.*

Letter rating	Speed rating - mph (km/h)
M	81 (130)
N	87 (140)
Q	99 (159)
R	106 (171)
S	112 (180)
T	118 (190)
U	124 (200)
H	130 (210)
V	149 (240)

## Wheels and Tires

Letter rating	Speed rating - mph (km/h)
W	168 (270)
Y	186 (299)

**Note:** For tires with a maximum speed capability over 149 mph (240 km/h), tire manufacturers sometimes use the letters ZR. For those with a maximum speed capability over 186 mph (299 km/h), tire manufacturers always use the letters ZR.

**H. U.S. DOT Tire Identification Number:** This begins with the letters DOT and indicates that the tire meets all federal standards. The next two numbers or letters are the plant code designating where it was manufactured, the next two are the tire size code and the last four numbers represent the week and year the tire was built. For example, the numbers 317 mean the 31st week of 1997. After 2000 the numbers go to four digits. For example, 2501 means the 25th week of 2001. The numbers in between are identification codes used for traceability. This information is used to contact customers if a tire defect requires a recall.

**I. M+S or M/S:** Mud and Snow, or

**AT:** All Terrain, or

**AS:** All Season.

**J. Tire Ply Composition and Material Used:** Indicates the number of plies or the number of layers of rubber-coated fabric in the tire tread and sidewall. Tire manufacturers also must indicate the ply materials in the tire and the sidewall, which include steel, nylon, polyester, and others.

**K. Maximum Load:** Indicates the maximum load in kilograms and pounds that can be carried by the tire. See the Safety Compliance Certification Label for the correct tire pressure for your vehicle. See the completed vehicle's owner's manual for the location of the Safety Compliance Certification Label.

**L. Treadwear, Traction and Temperature Grades:**

**\*Treadwear** The treadwear grade is a comparative rating based on the wear rate of the tire when tested under controlled conditions on a specified government test course. For example, a tire graded 150 would wear 1½ times as well on the government course as a tire graded 100.

**\*Traction:** The traction grades, from highest to lowest are AA, A, B, and C. The grades represent the tire's ability to stop on wet pavement as measured under controlled conditions on specified government test surfaces of asphalt and concrete. A tire marked C may have poor traction performance.

# Wheels and Tires

**\*Temperature:** The temperature grades are A (the highest), B and C, representing the tire's resistance to the generation of heat and its ability to dissipate heat when tested under controlled conditions on a specified indoor laboratory test wheel.

## M. Maximum Inflation

**Pressure:** Indicates the tire manufacturers' maximum permissible pressure or the pressure at which the maximum load can be carried by the tire. This pressure is normally higher than the vehicle manufacturer's recommended cold inflation pressure which can be found on the Safety Compliance Certification Label. See the completed vehicle's owner's manual for the location of the Safety Compliance Certification Label. The cold inflation pressure should never be set lower than the recommended pressure on the vehicle label.

The tire suppliers may have additional markings, notes or warnings such as standard load or radial tubeless.

## Additional Information Contained on the Tire Sidewall for LT Type Tires

**Note:** *Tire Quality Grades do not apply to this type of tire.*

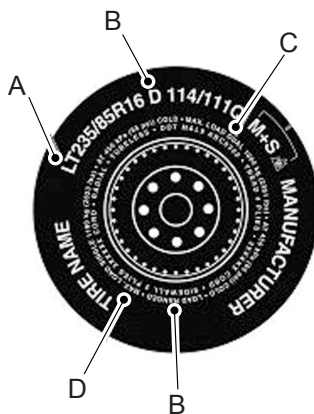

E142544

LT type tires have some additional information beyond those of P type tires; these differences are described below.

**A. LT:** Indicates a tire, designated by the Tire and Rim Association, that is intended for service on light trucks.

**B. Load Range and Load Inflation Limits:** Indicates the tire's load-carrying capabilities and its inflation limits.

**C. Maximum Load Dual lb (kg) at psi (kPa) cold:** Indicates the maximum load and tire pressure when the tire is used as a dual; defined as four tires on the rear axle (a total of six or more tires on the vehicle).

# Wheels and Tires

**D. Maximum Load Single lb (kg) at psi (kPa) cold:** Indicates the maximum load and tire pressure when the tire is used as a single; defined as two tires (total) on the rear axle.

## Information on T Type Tires

T145/80D16 is an example of a tire size.

**Note:** *The temporary tire size for your vehicle may be different from this example. Tire Quality Grades do not apply to this type of tire.*

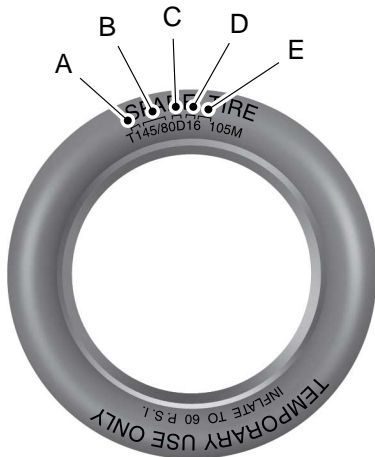

E142545

T type tires have some additional information beyond those of P type tires; these differences are described below:

**A. T:** Indicates a type of tire, designated by the Tire and Rim Association, that is intended for temporary service on cars, sport utility vehicles, minivans and light trucks.

**B. 145:** Indicates the nominal width of the tire in millimeters from sidewall edge to sidewall edge. In general, the larger the number, the wider the tire.

**C. 80:** Indicates the aspect ratio which gives the tire's ratio of height to width. Numbers of 70 or lower indicate a short sidewall.

**D. D:** Indicates a diagonal type tire.

**R:** Indicates a radial type tire.

**E. 16:** Indicates the wheel or rim diameter in inches. If you change your wheel size, you will have to purchase new tires to match the new wheel diameter.

## Inflating Your Tires

Safe operation of your vehicle requires that your tires are properly inflated. Remember that a tire can lose up to half of its air pressure without appearing flat.

Every day before you drive, check your tires. If one looks lower than the others, use a tire gauge to check pressure of all tires and adjust if required.

## Wheels and Tires

---

At least once a month and before long trips, inspect each tire and check the tire pressure with a tire gauge (including spare, if equipped). Inflate all tires to the inflation pressure recommended by Ford Motor Company.

You are strongly urged to buy a reliable tire pressure gauge, as automatic service station gauges may be inaccurate. Ford recommends the use of a digital or dial-type tire pressure gauge rather than a stick-type tire pressure gauge.

Use the recommended cold inflation pressure for optimum tire performance and wear. Under-inflation or over-inflation may cause uneven treadwear patterns

### WARNING



Under-inflation is the most common cause of tire failures and may result in severe tire cracking, tread separation or blowout, with unexpected loss of vehicle control and increased risk of injury. Under-inflation increases sidewall flexing and rolling resistance, resulting in heat buildup and internal damage to the tire. It also may result in unnecessary tire stress, irregular wear, loss of vehicle control and accidents. A tire can lose up to half of its air pressure and not appear to be flat!

---

Always inflate your tires to the Ford recommended inflation pressure even if it is less than the maximum inflation pressure information found on the tire. The Ford recommended tire inflation pressure is found on the Safety Compliance Certification Label or Tire Label. See the completed vehicle's owner's manual for the location of the Safety Compliance Certification Label or Tire Label. Failure to follow the tire pressure recommendations can cause uneven treadwear patterns and adversely affect the way your vehicle handles

**Maximum Inflation Pressure** is the tire manufacturer's maximum permissible pressure and the pressure at which the maximum load can be carried by the tire. This pressure is normally higher than the manufacturer's recommended cold inflation pressure which can be found on the Safety Compliance Certification Label or Tire Label. See the completed vehicle's owner's manual for the location of the Safety Compliance Certification Label or Tire Label. The cold inflation pressure should never be set lower than the recommended pressure on the Safety Compliance Certification Label or Tire Label.

## Wheels and Tires

---

When weather temperature changes occur, tire inflation pressures also change. A 10°F (6°C) temperature drop can cause a corresponding drop of 1 psi (7 kPa) in inflation pressure. Check your tire pressures frequently and adjust them to the proper pressure which can be found on the Safety Compliance Certification Label or Tire Label.

To check the pressure in your tire(s):

1. Make sure the tires are cool, meaning they are not hot from driving even a mile.

**Note:** *If you are checking tire pressure when the tire is hot, (for example, driven more than 1 mile [1.6 kilometers]), never bleed or reduce air pressure. The tires are hot from driving and it is normal for pressures to increase above recommended cold pressures. A hot tire at or below recommended cold inflation pressure could be significantly under-inflated.*

**Note:** *If you have to drive a distance to get air for your tire(s), check and record the tire pressure first and add the appropriate air pressure when you get to the pump. It is normal for tires to heat up and the air pressure inside to go up as you drive.*

2. Remove the cap from the valve on one tire, then firmly press the tire gauge onto the valve and measure the pressure.

3. Add enough air to reach the recommended air pressure.

**Note:** *If you overfill the tire, release air by pressing on the metal stem in the center of the valve. Then recheck the pressure with your tire gauge.*

4. Replace the valve cap.
5. Repeat this procedure for each tire, including the spare.

**Note:** *Some spare tires operate at a higher inflation pressure than the other tires. For T type mini-spare tires, see the Dissimilar spare wheel and tire assembly information for a description. Store and maintain at 60 psi (4.15 bar). For full-size and dissimilar spare tires, see the Dissimilar spare wheel and tire assembly information for a description. Store and maintain at the higher of the front and rear inflation pressure as shown on the Safety Compliance Certification Label or Tire Label.*

6. Visually inspect the tires to make sure there are no nails or other objects embedded that could poke a hole in the tire and cause an air leak.
7. Check the sidewalls to make sure there are no gouges, cuts or bulges.

# Wheels and Tires

## Tire Inflation Information

### WARNING

 An inflated tire and rim can be very dangerous if improperly used, serviced or maintained. To reduce the risk of serious injury, never attempt to re-inflate a tire which has been run flat or seriously under-inflated without first removing the tire from the wheel assembly for inspection. Do not attempt to add air to tires or replace tires or wheels without first taking precautions to protect persons and property.

All tires with Steel Carcass Plies (if equipped):

This type of tire utilizes steel cords in the sidewalls. As such, they cannot be treated like normal light truck tires. Tire service, including adjusting tire pressure, must be performed by personnel trained, supervised and equipped according to Federal Occupational Safety and Health Administration regulations. For example, during any procedure involving tire inflation, the technician or individual must utilize a remote inflation device, and ensure that all persons are clear of the trajectory area.

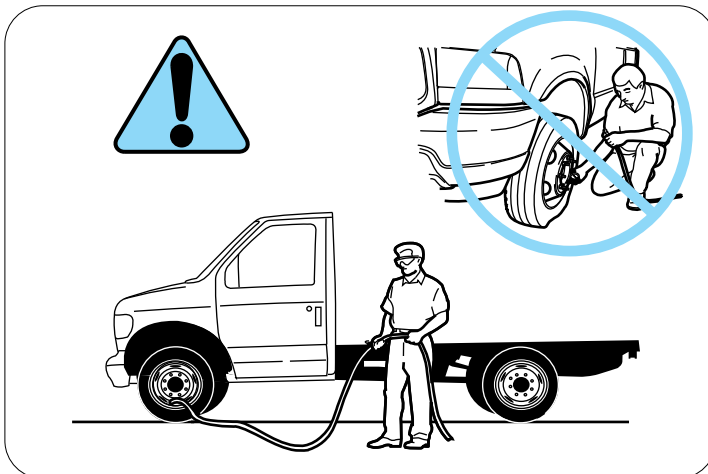

E161437

# Wheels and Tires

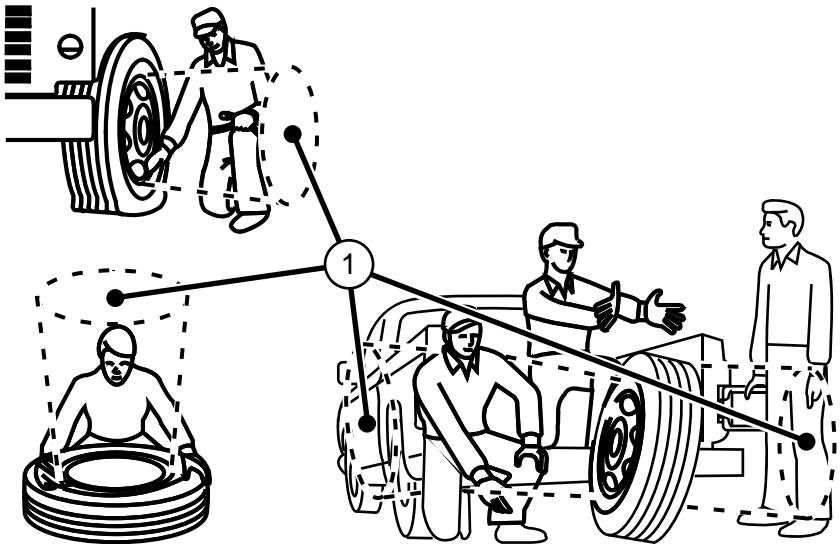

E161438

## WARNING



Stay out of the trajectory (1) as indicated in the illustration.

## Inspecting Your Tires and Wheel Valve Stems

Periodically inspect the tire treads for uneven or excessive wear and remove objects such as stones, nails or glass that may be wedged in the tread grooves. Check the tire and valve stems for holes, cracks, or cuts that may permit air leakage and repair or replace the tire and replace the valve stem. Inspect the tire sidewalls for cracking, cuts, bruises and other signs of damage or excessive

wear. If internal damage to the tire is suspected, have the tire demounted and inspected in case it needs to be repaired or replaced. For your safety, tires that are damaged or show signs of excessive wear should not be used because they are more likely to blow out or fail.

Improper or inadequate vehicle maintenance can cause tires to wear abnormally. Inspect all your tires, including the spare, frequently, and replace them if one or more of the following conditions exist:



# Wheels and Tires

## Tire Wear

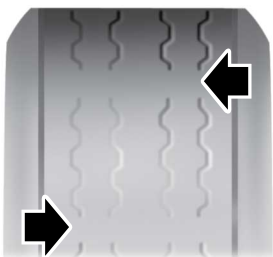

E142546

When the tread is worn down to one sixteenth of an inch (2 millimeters), tires must be replaced to help prevent your vehicle from skidding and hydroplaning. Built-in treadwear indicators, or wear bars, which look like narrow strips of smooth rubber across the tread will appear on the tire when the tread is worn down to one sixteenth of an inch (2 millimeters).

When the tire tread wears down to the same height as these wear bars, the tire is worn out and must be replaced.

## Damage

Periodically inspect the tire treads and sidewalls for damage (such as bulges in the tread or sidewalls, cracks in the tread groove and separation in the tread or sidewall). If damage is observed

or suspected have the tire inspected by a tire professional. Tires can be damaged during off-road use, so inspection after off-road use is also recommended.

## Age

### WARNING

 Tires degrade over time depending on many factors such as weather, storage conditions, and conditions of use (load, speed, inflation pressure) the tires experience throughout their lives.

In general, tires should be replaced after six years regardless of tread wear. However, heat caused by hot climates or frequent high loading conditions can accelerate the aging process and may require tires to be replaced more frequently.

You should replace your spare tire when you replace the road tires or after six years due to aging even if it has not been used.

## U.S. DOT Tire Identification Number

Both United States and Canada Federal regulations require tire manufacturers to place standardized information on the sidewall of all tires. This information identifies and

# Wheels and Tires

describes the fundamental characteristics of the tire and also provides a U.S. DOT Tire Identification Number for safety standard certification and in case of a recall.

This begins with the letters DOT and indicates that the tire meets all federal standards. The next two numbers or letters are the plant code designating where it was manufactured, the next two are the tire size code and the last four numbers represent the week and year the tire was built. For example, the numbers 317 mean the 31st week of 1997. After 2000 the numbers go to four digits. For example, 2501 means the 25th week of 2001. The numbers in between are identification codes used for traceability. This information is used to contact customers if a tire defect requires a recall.

## Tire Replacement Requirements

Your vehicle is equipped with tires designed to provide a safe ride and handling capability.

### WARNINGS



Only use replacement tires and wheels that are the same size, load index, speed rating and type (such as P-metric versus LT-metric or all-season versus all-terrain) as those originally provided by Ford. The recommended tire and wheel size

### WARNINGS

may be found on either the Safety Compliance Certification Label or the Tire Label. If this information is not found on these labels then you should contact your authorized dealer as soon as possible. Use of any tire or wheel not recommended by Ford can affect the safety and performance of your vehicle, which could result in an increased risk of loss of vehicle control, vehicle rollover, personal injury and death. Additionally the use of non-recommended tires and wheels could cause steering, suspension, axle, transfer case or power transfer unit failure. If you have questions regarding tire replacement, contact your authorized dealer as soon as possible.



To reduce the risk of serious injury, when mounting replacement tires and wheels, you should not exceed the maximum pressure indicated on the sidewall of the tire to set the beads without additional precautions listed below. If the beads do not seat at the maximum pressure indicated, re-lubricate and try again

# Wheels and Tires

---

## WARNINGS

When inflating the tire for mounting pressures up to 20 psi (1.38 bar) greater than the maximum pressure on the tire sidewall, the following precautions must be taken to protect the person mounting the tire:

1. Make sure that you have the correct tire and wheel size.
2. Lubricate the tire bead and wheel bead seat area again.
3. Stand at a minimum of 12 feet (3.6 meters) away from the wheel and tire assembly.
4. Use both eye and ear protection.

For a mounting pressure more than 20 psi (1.38 bar) greater than the maximum pressure, a Ford dealer or other tire service professional should do the mounting.

Always inflate steel carcass tires with a remote air fill with the person inflating standing at a minimum of 12 feet (3.6 meters) away from the wheel and tire assembly

---

**Important:** Remember to replace the wheel valve stems when the road tires are replaced on your vehicle

It is recommended that the two front tires or two rear tires generally be replaced as a pair.

## Replacing a Tire That is Greenhouse Gas Certified

The tires installed on this vehicle at the factory as original equipment are certified for Greenhouse Gas and Fuel Efficiency regulations. Replacement tires must be of equal or lower rolling resistance level (TRRL or Crr). Consult with your tire supplier(s) for appropriate replacement tires.

## Safety Practices

### WARNINGS



If your vehicle is stuck in snow, mud, or sand, do not rapidly spin the tires; spinning the tires can tear the tire and cause an explosion. A tire can explode in as little as three to five seconds.



Do not spin the wheels at over 35 mph (56 km/h). The tires may fail and injure a passenger or bystander.

---

## Driving habits have a great deal to do with your tire mileage and safety.

- \*Observe posted speed limits
- \*Avoid fast starts, stops and turns
- \*Avoid potholes and objects on the road

# Wheels and Tires

---

\*Do not run over curbs or hit the tire against a curb when parking

## Highway Hazards

No matter how carefully you drive there's always the possibility that you may eventually have a flat tire on the highway. Drive slowly to the closest safe area out of traffic.

This may further damage the flat tire, but your safety is more important.

If you feel a sudden vibration or ride disturbance while driving, or you suspect your tire or vehicle has been damaged, immediately reduce your speed. Drive with caution until you can safely pull off the road. Stop and inspect the tires for damage. If a tire is under-inflated or damaged, deflate it, remove wheel and replace it with your spare tire and wheel. If you cannot detect a cause, have the vehicle towed to the nearest repair facility or tire dealer to have the vehicle inspected.

## Tire and Wheel Alignment

A bad jolt from hitting a curb or pothole can cause the front end of your vehicle to become misaligned or cause damage to your tires. If your vehicle seems to pull to one side when you're driving, the wheels may be out of alignment. Have an authorized dealer check the wheel alignment periodically.

Wheel misalignment in the front or the rear can cause uneven and rapid treadwear of your tires and should be corrected by an authorized dealer. Front-wheel drive vehicles and those with an independent rear suspension may require alignment of all four wheels.

The tires should also be balanced periodically. An unbalanced tire and wheel assembly may result in irregular tire wear.

## Tire Rotation

**Note:** *If your tires show uneven wear ask an authorized dealer to check for and correct any wheel misalignment, tire imbalance or mechanical problem involved before tire rotation.*

**Note:** *Your vehicle may be equipped with a dissimilar spare wheel and tire assembly. A dissimilar spare wheel and tire assembly is defined as a spare wheel and tire assembly that is different in brand, size or appearance from the road tires and wheels. If you have a dissimilar spare wheel and tire assembly it is intended for temporary use only and should not be used in a tire rotation.*

**Note:** *After having your tires rotated, inflation pressure must be checked and adjusted to the vehicle requirements.*

# Wheels and Tires

Rotating your tires at the recommended interval (as indicated in the Scheduled Maintenance chapter) will help your tires wear more evenly, providing better tire performance and longer tire life.

Dual rear wheel drive vehicle - six tire rotation

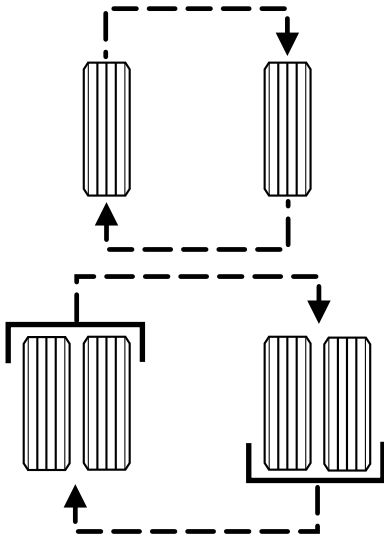

E161439

If your vehicle is equipped with dual rear wheels it is recommended that the front and rear tires (in pairs) be rotated only side to side. We do not recommend splitting up the dual

rear wheels. Rotate them side to side as a set. After tire rotation, inflation pressures must be adjusted for the tires new positions in accordance with vehicle requirements.

Sometimes irregular tire wear can be corrected by rotating the tires.

## USING SNOW CHAINS

### WARNING



Snow tires must be the same size, load index, speed rating as those originally provided by Ford. Use of any tire or wheel not recommended by Ford can affect the safety and performance of your vehicle, which could result in an increased risk of loss of vehicle control, vehicle rollover, personal injury and death. Additionally, the use of non-recommended tires and wheels could cause steering, suspension, axle, transfer case or power transfer unit failure.

The tires on your vehicle have all-weather treads to provide traction in rain and snow. However, in some climates, you may need to use snow tires and cables. If you need to use cables, it is recommended that steel wheels (of the same size and specifications) be used, as cables may chip aluminum wheels.

**Note:** *The suspension insulation and bumpers will help prevent vehicle damage. Do not remove these components from your vehicle when using snow tires and chains.*

Follow these guidelines when using snow tires and chains:

- If possible, avoid fully loading your vehicle
- Use only SAE Class S chains.

# Wheels and Tires

- Install chains securely, verifying that the chains do not touch any wiring, brake lines or fuel lines.
- Drive cautiously. If you hear the chains rub or bang against your vehicle, stop and retighten the chains. If this does not work, remove the chains to prevent damage to your vehicle.
- Remove the tire chains when they are no longer needed. Do not use tire chains on dry roads.

If you have any questions regarding snow chains or cables, please contact your authorized dealer.

## CHANGING A ROAD WHEEL

If you get a flat tire while driving, do not apply the brake heavily. Instead, gradually decrease your speed. Hold the steering wheel firmly and slowly move to a safe place on the side of the road.

### Dissimilar Spare Wheel and Tire Assembly Information

#### WARNING



Failure to follow these guidelines could result in an increased risk of loss of vehicle control, injury or death.

If you have a dissimilar spare wheel and tire, then it is intended for temporary use only. This means that if you need to use it, you should replace it as soon as possible with a road wheel and tire assembly that is the same size and type as the road tires and wheels that were originally provided by Ford. If the dissimilar spare tire or wheel is damaged, it should be replaced rather than repaired.

A dissimilar spare wheel and tire assembly is defined as a spare wheel and tire assembly that is different in brand, size or appearance from the road tires and wheels and can be one of three types:

1. **T-type mini-spare:** This spare tire begins with the letter T for tire size and may have Temporary Use Only molded in the sidewall.
2. **Full-size dissimilar spare with label on wheel:** This spare tire has a label on the wheel that states: THIS WHEEL AND TIRE ASSEMBLY FOR TEMPORARY USE ONLY

When driving with one of the dissimilar spare tires listed above, do not:

- Exceed 50 mph (80 km/h).
- Load the vehicle beyond maximum vehicle load rating listed on the Safety Compliance Label.
- Tow a trailer.
- Use snow chains on the end of the vehicle with the dissimilar spare tire.
- Use more than one dissimilar spare tire at a time.
- Use commercial car washing equipment.
- Try to repair the dissimilar spare tire.

Use of one of the dissimilar spare tires listed above at any one wheel location can lead to impairment of the following:

- Handling, stability and braking performance.
- Comfort and noise.
- Ground clearance and parking at curbs.
- Winter weather driving capability.
- Wet weather driving capability.
- All-wheel driving capability

3. **Full-size dissimilar spare without label on wheel**

# Wheels and Tires

When driving with the full-size dissimilar spare wheel and tire assembly, do not:

- Exceed 70 mph (113 km/h).
- Use more than one dissimilar spare wheel and tire assembly at a time.
- Use commercial car washing equipment.
- Use snow chains on the end of the vehicle with the dissimilar spare wheel and tire assembly.

The usage of a full-size dissimilar spare wheel and tire assembly can lead to impairment of the following:

- Handling, stability and braking performance.
- Comfort and noise.
- Ground clearance and parking at curbs.
- Winter weather driving capability.
- Wet weather driving capability.
- All-wheel driving capability

When driving with the full-size dissimilar spare wheel and tire assembly additional caution should be given to:

- Towing a trailer.
- Driving vehicles equipped with a camper body.
- Driving vehicles with a load on the cargo rack.

Drive cautiously when using a full-size dissimilar spare wheel and tire assembly and seek service as soon as possible.

## Tire Change Procedure

### WARNINGS

 When one of the front wheels is off the ground, the transmission alone will not prevent the vehicle from moving or slipping off the jack, even if the transmission is in park (P).

### WARNINGS

 To help prevent the vehicle from moving when you change a tire, be sure to place the transmission in park (P), set the parking brake and block (in both directions) the wheel that is diagonally opposite (other side and end of the vehicle) to the tire being changed.

 Never get underneath a vehicle that is supported only by a jack. If the vehicle slips off the jack, you or someone else could be seriously injured.

 Do not attempt to change a tire on the side of the vehicle close to moving traffic. Pull far enough off the road to avoid the danger of being hit when operating the jack or changing the wheel.

 Always use the jack provided as original equipment with your vehicle. If using a jack other than the one provided as original equipment with your vehicle, make sure the jack capacity is adequate for the vehicle weight, including any vehicle cargo or modifications.

1. Park on a level surface, set the parking brake and activate the hazard flashers.
2. Place the transmission in park (P) and turn the engine off.

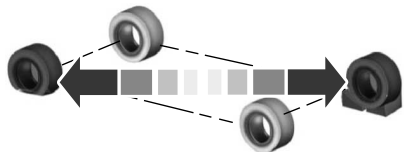

E175447

# Wheels and Tires

- Block the diagonally opposite wheel. The parking brake is on the transmission. Therefore, the vehicle will not be prevented from moving when a rear wheel is lifted, even if the parking brake is applied. Be sure to block both directions of the wheel that is diagonally opposite to the wheel that is being lifted.
- Remove the spare tire and jack from the storage location.
- Loosen the wheel nut by pulling up on the handle of the lug nut wrench about one-half turn (counterclockwise). Do not remove the wheel lug nuts until you raise the tire off the ground.
- Position the jack to raise the front or rear wheel. Raise the vehicle with the jack applied to the axle(s).
- Note:** Never use the rear differential as a jacking point.
- Raise the vehicle until the wheel is completely off the ground.
- Remove the lug nuts with the lug nut wrench.
- Replace the flat tire with the spare tire.

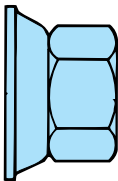

E161440

- Use the lug nut wrench to screw the lug nut snugly against the wheel.
- Lower the vehicle.
- Remove the jack and fully tighten the lug nuts in the order shown.

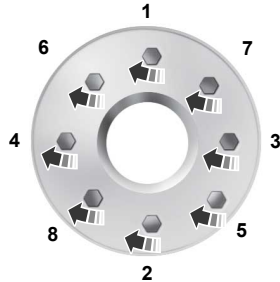

E161441

8-lug nut wheel



E169375

10-lug nut wheel

- Replace any wheel trim.
- Stow the jack, handle and lug wrench.
- Unblock the wheels.



# Wheels and Tires

## TECHNICAL SPECIFICATIONS

### Wheel Lug Nut Torque Specifications

#### WARNING



When a wheel is installed, always remove any corrosion, dirt or foreign materials present on the mounting surfaces of the wheel or the surface of the wheel hub, brake drum or brake disc that contacts the wheel. Make sure that any fasteners that attach the rotor to the hub are secured so they do not interfere with the mounting surfaces of the wheel. Installing wheels without correct metal-to-metal contact at the wheel mounting surfaces can cause the wheel nuts to loosen and the wheel to come off while the vehicle is in motion, resulting in loss of control.

Bolt size	lb-ft (Nm)*
M14 x 1.5 (19.5 inch wheels)	150 (200)
M22 x 1.5 (22.5 inch wheels)	450 (610)

\*Torque specifications are for nut and bolt threads free of dirt and rust. Use only Ford recommended replacement fasteners.

On vehicles equipped with dual rear wheels, retighten the wheel lug nuts to the specified torque at 100 miles (160 kilometers), and again at 500 miles (800 kilometers) of new vehicle operation and after any wheel disturbance (such as tire rotation, changing a flat tire, wheel removal).

On all two-piece flat wheel nuts, apply one drop of motor oil between the flat washer and the nut. Do not apply motor oil to the wheel nut threads or the wheel stud threads.



E161443

# Capacities and Specifications

## ENGINE SPECIFICATIONS

Engine	6.8L V10 engine
Cubic inches	415
Required fuel	Minimum 87 octane
Firing order	1-6-5-10-2-7-3-8-4-9
Ignition system	Coil on plug
Spark plug gap	0.039-0.043 inch (1.00-1.10mm)
Compression ratio	9.2:1

### Drivebelt Routing

#### Engines with A/C



E161788

#### Engines without A/C

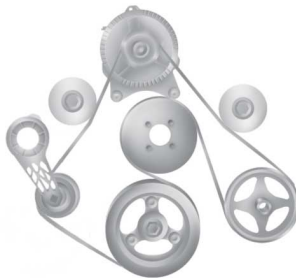

E161789

## Capacities and Specifications

---

- A. Long drivebelt is on first pulley groove closest to engine
- B. Short drivebelt is on second pulley groove farthest from engine

### MOTORCRAFT PARTS

Component	6.8L V10 engine
Air filter element	FA-1782
Battery	BXT-65-750
Oil filter	FL-820-S
Spark plugs	SP-509
Transmission fluid filter	FT-180

We recommend Motorcraft replacement parts available at your Ford dealer or at [fordparts.com](http://fordparts.com) for scheduled maintenance. These parts meet or exceed Ford Motor Company's specifications and are engineered for your vehicle. Use of other parts may impact vehicle performance, emissions and durability. Your warranty may be void for any damage related to use of other parts.

If a Motorcraft oil filter is not available, use an oil filter that meets industry performance specification SAE/USCAR-36.

For spark plug replacement, contact an authorized dealer. Replace the spark plugs at the appropriate intervals. See **Scheduled Maintenance** (page 121).

# Capacities and Specifications

## VEHICLE IDENTIFICATION NUMBER

The vehicle identification number is located near the cowl to the right of the air filter.

If you ever find it necessary to communicate with Ford Motor Company about your vehicle, always include the VIN in your communication. The Vehicle Identification Number (VIN) contains the following information:

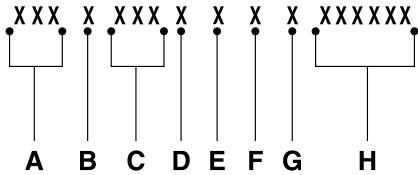

E142477

- A World manufacturer identifier
- B Brake system, Gross Vehicle Weight Rating, Restraint Devices and their locations
- C Make, vehicle line, series, body type
- D Engine type
- E Check digit
- F Model year
- G Assembly plant
- H Production sequence number

## VEHICLE CERTIFICATION LABEL

**MFD. BY FORD MOTOR CO.**

DATE: XX/XX	GVWR: XXXX KG (XXXX LB)
FRONT GAWR: XXXX KG (XXXX LB)	REAR GAWR: XXXX KG (XXXX LB)
XXXXXXXXXXXXXXXXXX	WITH TIRES XXXXXXXXXXXXXXXX
XXXXXXXX	RIMS XXXXXXXX
AT XXXX kPa/ XXX PSI COLD	AT XXXX kPa/ XXX PSI COLD

THIS VEHICLE CONFORMS TO ALL APPLICABLE FEDERAL MOTOR VEHICLE SAFETY AND THEFT PREVENTION STANDARDS IN EFFECT ON THE DATE OF MANUFACTURE SHOWN ABOVE.

VIN: XXXXXXXXXXXXXXXXXXXX XXXXX  
XXXXX

EXT PNT: XX	XXXXXX	1 RC: XX	DSO: XXXX
WB	1 INT TR	1 TP/PS	1 R AXLE
XXX	XX	XXX X	XX X
		XXXX XXXX	XXXX XXXX
		XXXXXXXXXXXXXX	XXXX XXXX-XXXXXXXX-XX

E167469

The National Highway Traffic Safety Administration Regulations require that a Safety Compliance Certification Label be affixed to a vehicle and prescribe where the Safety Compliance Certification Label may be located. The Safety Compliance Certification Label shall be affixed to either the door hinge pillar, the door latch post, or the edge of the door near the door latch, next to the driver's seating position.

# Capacities and Specifications

## TRANSMISSION CODE DESIGNATION

The transmission code is on the Safety Compliance Certification Label. The following table shows the transmission code along with the transmission description.

MFD. BY FORD MOTOR CO.

DATE: XX/XX      GVWR: XXXX KG (XXXX LB)  
 FRONT GAWR:      REAR GAWR:  
 XXXX KG (XXXX LB)      WITH XXXX KG (XXXX LB)      WITH  
 XXXXXXXXXXXXXXXX      TIRES XXXXXXXXXXXXXXXX      TIRES  
 XXXXXXXX      RIMS XXXXXXXX      RIMS  
 AT XXXX kPa/ XXX PSI COLD      AT XXXX kPa/ XXX PSI COLD

THIS VEHICLE CONFORMS TO ALL APPLICABLE FEDERAL MOTOR  
 VEHICLE SAFETY AND THEFT PREVENTION STANDARDS IN  
 EFFECT ON THE DATE OF MANUFACTURE SHOWN ABOVE.

VIN: XXXXXXXXXXXXXXXXXXXX      XXXXX  
 TYPE: XXXX      XXXXX



EXT PNT: XX      XXXXX      RC: XX      DSO: XXXX  
 WB    INT TR    TP/PS    TR    AXLE    TR    SPR    XXXX  
 XXX    XX      XXX    X    XX    X    XXXX    XXXX  
 XXXXXXXXXXXX      X      =XXXX-XXXXXX-XX

↑

E167814

Description	Code
Five-speed automatic transmission (5R110W)	T

# Capacities and Specifications

## TECHNICAL SPECIFICATIONS

Item	Capacity	Ford part name or equivalent	Ford part number / Ford specification
Brake fluid <sup>1</sup> -Hydro-boost brake booster system—Chassis with Gross Vehicle Weight Ratings of 16000 lb (7257 kg), 18000 lb (8165 kg) and 19500 lb (8845 kg)	Between MIN and MAX on reservoir	Motorcraft High Performance DOT 4 LV Motor Vehicle Brake Fluid	PM-20 / WSS-M6C65-A2
Brake fluid-Hydromax brake booster system—Chassis with Gross Vehicle Weight Ratings of 20500 lb (9299 kg), 22000 lb (9979 kg), 24000 lb (10886 kg) and 26000 lb (11793 kg)	Between MIN and MAX on reservoir	DOT 5.1 Motor Vehicle Brake Fluid	YS4Z-19542-AA / ESD-M6C57-A or WSS-M6C65-A2
Engine coolant <sup>2,3</sup>	30.6 qt (29.0L)	Motorcraft Premium Gold Engine Coolant (yellow-colored)	VC-7-B (U.S.) / WSS-M97B51-A1
			CVC-7-B (Canada) / WSS-M97B51-A1
Engine oil <sup>4,5,6</sup>	7.0 qt (6.6L)	Motorcraft SAE 5W-20 Motor Oil or equivalent	XO-5W20-QSP or XO-5W20-QFS (U.S.) / WSS-M2C945-A
			CXO-5W20-LSP12 or CXO-5W20-LFS12 (Canada) / WSS-M2C945-A
Automatic transmission TorqShift 5-speed <sup>7,8</sup>	18.2 qt (17.2L)	Motorcraft MERCON LV	XT-10-QLV / WSS-M2C938-A
Power steering fluid	Keep in FULL range on dipstick	Motorcraft MERCON V	XT-5-QM / WSS-M2C938-A
Parking brake assembly	Fill to bottom of fill plug hole		

## Capacities and Specifications

Item	Capacity	Ford part name or equivalent	Ford part number / Ford specification
Rear axle lubricant <sup>9,10</sup>	Dana M80 axle 4.0 qt (3.9L)	Motorcraft SAE 75W-140 Synthetic Rear Axle Lubricant	XY-75W140-QL (U.S.) / WSL-M2C192-A and GL-5
	Dana S110 axle 8.0 qt (7.6L)		
	Dana S130 axle 7.0 qt (6.6L)		
	Dana Spicer 17060S axle 16.0 qt (15.1L)		CXY-75W140-1L (Canada) / WSL-M2C192-A and GL-5
Transmission, steering and parking brake link- ages and pivots, brake pedal shaft	—	Premium Long-Life Grease	XG-1-E
Windshield washer fluid	Fill as required	Motorcraft Premium Windshield Washer Concentrates with Bitterant (U.S.)	ZC-32-A / WSB-M8B16-A2
		Motorcraft Premium Quality Wind- shield Washer Fluid (Canada)	CXC-37-(A, B, D, and F) / WSB-M8B16-A2
Fuel tank	Motorhome 80 gal (303L)	Not applicable	Not applicable
	Commercial chassis 40 gal (151L)	Not applicable	Not applicable
A/C Refrigerant <sup>11</sup>	1.74 lb (0.79 kg)	Motorcraft R- 134a Refri- gerant	YN-19 (U.S.) / WSH-M17B19-A
			CYN16-R (Canada) / WSH-M17B19-A

## Capacities and Specifications

Item	Capacity	Ford part name or equivalent	Ford part number / Ford specification
A/C Refrigerant Compressor Oil <sup>11</sup>	—	Motorcraft PAG Refrigerant Compressor Oil	YN-12-D / WSH-MIC231-B

<sup>1</sup>Ford recommends using Motorcraft (Ford) DOT 4 LV High Performance Motor Vehicle Brake Fluid or equivalent meeting WSS-M6C65-A2. Use of any fluid other than the recommended fluid may cause degraded brake performance and not meet the Ford performance standards. Keep brake fluid clean and dry. Contamination with dirt, water, petroleum products or other materials may result in brake system damage and possible failure.

<sup>2</sup>Capacity is approximate and will vary due to second-stage manufacturer completion of HVAC system. Fill to the Cold Fill Level on reservoir.

<sup>3</sup>Add the coolant type originally equipped in your vehicle.

<sup>4</sup>The design of your engine allows for the use of Motorcraft engine oils or equivalent oils that meet Ford specifications. It is also acceptable to use an engine oil of recommended viscosity grade that meets API SN requirements and displays the API certification mark for gasoline engines.

<sup>5</sup>Do not use supplemental engine oil additives in your engine. They are unnecessary and could lead to engine damage not covered by your warranty.

<sup>6</sup>Do not use API category oils labeled SN, SM, SL or lower category unless the label also displays the API certification mark. These oils do not meet the requirements of your engine and emission systems.

<sup>7</sup>Indicates only approximate dry-fill capacity. Some applications may vary based on cooler size and if equipped with in-tank cooler. Use the indication on the dipstick, showing the normal operating range, to determine the amount of transmission fluid and the fluid level.

<sup>8</sup>Automatic transmissions that require Motorcraft MERCON LV transmission fluid should only use Motorcraft MERCON LV transmission fluid. Use of any fluid other than the recommended fluid may cause transmission damage. Change the automatic transmission fluid and filter at the correct service interval.

<sup>9</sup>Filled with a synthetic rear axle lubricant, consider the rear axle on your vehicle filled for life. You do not need to check or change the rear axle lubricant unless you suspect a leak. Change the rear axle lubricant any time you have submerged the rear axle in water.



## Capacities and Specifications

Item	Capacity	Ford part name or equivalent	Ford part number / Ford specification
<sup>9</sup> Your axle is filled with a synthetic rear axle lubricant. Consider the rear axle on your vehicle filled for life. You do not need to check or change the rear axle lubricant unless you suspect a leak. Change the rear axle lubricant any time you have submerged the rear axle in water.			
<sup>9</sup> Filled with a synthetic rear axle lubricant, consider the rear axle on your vehicle filled for life. You do not need to check or change the rear axle lubricant unless you suspect a leak. Change the rear axle lubricant any time you have submerged the rear axle in water.			
<sup>10</sup> Service refill capacity is determined by filling the axle to 1/4-9/16 inch (6-14 millimeters) below the bottom of the filler hole with the vehicle on a level surface.			
<sup>11</sup> See the warning below:			

### WARNING



The air conditioning refrigerant system contains refrigerant R-134a under high pressure. Opening the air conditioning refrigerant system can cause personal injury. Have the air conditioning refrigerant system serviced only by qualified personnel.

# Extended Service Plan (ESP)

---

PROTECT YOURSELF FROM THE RISING COST OF VEHICLE REPAIRS WITH A FORD EXTENDED SERVICE PLAN.

## **SERVICE PLANS (U.S. Only)**

More than 32 million Ford owners have discovered the powerful protection of Ford Extended Service Plan. It is the only extended service plan backed by Ford Motor Company, and provides peace of mind protection beyond the New Vehicle Limited Warranty coverage.

### **Ford ESP Can Quickly Pay for Itself**

One service bill – the cost of parts and labor – can easily exceed the price of your Ford Extended Service Plan. With Ford ESP you minimize your risk for unexpected repair bills and rising repair costs.

### **Up to 1,000+ Covered Vehicle Components**

There are four Extended Service Plans with different levels of coverage. Ask your authorized dealer for details.

1. PremiumCARE - Our most comprehensive coverage. With over 1,000 covered components, this plan is so complete that we generally only discuss what's not covered.
2. ExtraCARE - Covers 113 components, and includes many high-tech items.
3. BaseCARE - Covers 84 components.
4. PowertrainCARE - Covers 29 critical components.

Ford Extended Service Plan is honored by all authorized Ford dealers in the U.S. and Canada. It is the only extended service plan authorized and backed by Ford Motor Company.

That means you get:

- Reliable, quality service at any Ford or Lincoln dealership
- Repairs performed by factory trained technicians, using genuine parts

### **Rental Car Reimbursement**

#### ***1st day Rental Benefit***

You take advantage of replacement transportation if your vehicle is at your authorized dealer for same day covered repairs.

#### ***Extended Rental Benefits***

If your vehicle is kept overnight for covered repairs, you are eligible for rental car coverage, including bumper to bumper warranty repairs, and Field Service Actions.

### **Roadside Assistance**

Exclusive 24/7 roadside assistance, including:

- Towing, flat-tire change and battery jump starts
- Out of fuel and lock-out assistance.
- Travel expense reimbursement for lodging, meals and rental car.
- Destination assistance for taxi, shuttle, rental car coverage and emergency transportation.

### **Transferable Coverage**

If you sell your vehicle before your Ford Extended Service Plan coverage expires, you can transfer any remaining coverage to the new owner. Whenever you sell your vehicle, prospective buyers may have a higher degree of confidence that vehicle was properly maintained with Ford ESP, thereby improving resale value.

# Extended Service Plan (ESP)

---

## Avoid the Rising Cost of Properly Maintaining Your Vehicle!

Ford Extended Service Plan also offers a Premium Maintenance Plan that covers all scheduled maintenance, and selected wear items. The coverage is prepaid, so you never have to worry about affording your vehicle's maintenance. It covers regular checkups, routine inspections, preventive care and replacement of select items that require periodic attention for normal wear:

- Windshield wiper blades.
- Spark plugs (except in California).
- The clutch disc.
- Brake pads and linings.
- Shock absorbers.
- Belts and hoses.
- Diesel exhaust fluid replenishment.

## Interest Free Finance Options Available

Take advantage of our interest free installment payment plan. Just a 10% down payment will provide you with an affordable, no interest, no fee payment program allowing you all the security and benefits Ford ESP has to offer while paying over time. You are pre-approved with no credit checks, no hassles! To learn more, call our Ford ESP specialists at 800-367-3377.

Ford ESP  
P.O. Box 8072  
Royal Oak, MI 48068-0039

## SERVICE PLANS (CANADA ONLY)

You can get more protection for your vehicle by purchasing a Ford Extended Service Plan. Ford Extended Service Plan is the only service contract backed by Ford Motor Company of Canada, Limited. Depending on the plan you purchase, Ford Extended Service Plan provides benefits such as:

- Rental reimbursement.
- Coverage for certain maintenance and wear items.
- Protection against repair costs after your New Vehicle Limited Warranty Coverage expires.
- Roadside Assistance benefits.

There are several Ford Extended Service Plans available in various time, distance and deductible combinations. Each plan is tailored to fit your own driving needs, including reimbursement for towing and rental. When you purchase Ford Extended Service Plan, you receive added peace-of-mind protection throughout Canada and the United States, provided by a network of participating authorized Ford Motor Company dealers.

**Note:** *Repairs performed outside of Canada and the United States are not eligible for Ford Extended Service Plan coverage.*

This information is subject to change. For more information, visit your local Ford of Canada dealer or [www.ford.ca](http://www.ford.ca) to find the Ford Extended Service Plan that is right for you.

# Scheduled Maintenance

---

## GENERAL MAINTENANCE INFORMATION

### Why Maintain Your Vehicle?

Carefully following the maintenance schedule helps protect against major repair expenses resulting from neglect or inadequate maintenance and may help to increase the value of your vehicle when you sell or trade it. Keep all receipts for completed maintenance with your vehicle.

We have established regular maintenance intervals for your vehicle based upon rigorous testing. It is important that you have your vehicle serviced at the proper times. These intervals serve two purposes; one is to maintain the reliability of your vehicle and the second is to keep your cost of owning your vehicle down.

It is your responsibility to have all scheduled maintenance performed and to make sure that the materials used meet the specifications identified in this owner's manual. See **Capacities and Specifications** (page 111).

Failure to perform scheduled maintenance invalidates warranty coverage on parts affected by the lack of maintenance.

### Why Maintain Your Vehicle at Your Dealership?

#### Factory-trained Technicians

Service technicians participate in extensive factory-sponsored certification training to help them become experts on the operation of your vehicle. Ask your dealership about the training and certification their technicians have received.

### Genuine Ford and Motorcraft Replacement Parts

Dealerships stock Ford, Motorcraft and Ford-authorized branded re-manufactured replacement parts. These parts meet or exceed our specifications. Parts installed at your dealership carry a nationwide 24-month or unlimited mile (kilometer) parts and labor limited warranty.

If you do not use Ford authorized parts they may not meet our specifications and depending on the part, it could affect emissions compliance.

### Convenience

Many dealerships have extended evening and Saturday hours to make your service visit more convenient and they offer one stop shopping. They can perform any services that are required on your vehicle, from general maintenance to collision repairs.

**Note:** *Not all dealers have extended hours or body shops. Please contact your dealer for details.*

### Protecting Your Investment

Maintenance is an investment that pays dividends in the form of improved reliability, durability and resale value. To maintain the proper performance of your vehicle and its emission control systems, make sure you have scheduled maintenance performed at the designated intervals.

Your vehicle is very sophisticated and built with multiple, complex, performance systems. Every manufacturer develops these systems using different specifications and performance features. That is why it is important to rely upon your dealership to properly diagnose and repair your vehicle.

# Scheduled Maintenance

Ford Motor Company has recommended maintenance intervals for various parts and component systems based upon engineering testing. Ford Motor Company relies upon this testing to determine the most appropriate mileage for replacement of oils and fluids to protect your vehicle at the lowest overall cost to you and recommends against maintenance schedules that deviate from the scheduled maintenance information.

We strongly recommend the use of only genuine Ford, Motorcraft or Ford-authorized re-manufactured replacement parts engineered for your vehicle.

## Additives and Chemicals

This owner's manual and the Ford Workshop Manual list the recommended additives and chemicals for your vehicle. We do not recommend using chemicals or additives not approved by us as part of your vehicle's normal maintenance. Please consult your warranty information.

## Oils, Fluids and Flushing

In many cases, fluid discoloration is a normal operating characteristic and, by itself, does not necessarily indicate a concern or that the fluid needs to be changed. However, a qualified expert, such as the factory-trained technicians at your dealership, should inspect discolored fluids that also show signs of overheating or foreign material contamination immediately.

Make sure to change your vehicle's oils and fluids at the specified intervals or in conjunction with a repair. Flushing is a viable way to change fluid for many vehicle sub-systems during scheduled maintenance. It is critical that systems are flushed only with new fluid that is the same as that required to fill and operate the system or using a Ford-approved flushing chemical.

## Owner Checks and Services

Make sure you perform the following basic maintenance checks and inspections every month or at six-month intervals.

<b>Check every month</b>
Engine oil level.
Function of all interior and exterior lights.
Tires (including spare) for wear and proper pressure.
Windshield washer fluid level.

<b>Check every six months</b>
Battery connections. Clean if necessary.
Body and door drain holes for obstructions. Clean if necessary.
Cooling system fluid level and coolant strength.
Door weatherstrips for wear. Lubricate if necessary.

# Scheduled Maintenance

Check every six months
Hinges, latches and outside locks for proper operation. Lubricate if necessary.
Parking brake for proper operation.
Safety belts and seat latches for wear and function.
Safety warning lamps (brake, ABS, airbag and safety belt) for operation.
Washer spray and wiper operation. Clean or replace blades as necessary.

## Multi-point Inspection

In order to keep your vehicle running right, it is important to have the systems on your vehicle checked regularly. This can help identify potential issues and prevent major problems. We recommend having the following multi-point inspection performed at every scheduled maintenance interval to help make sure your vehicle keeps running great.

Multi-point inspection	
Accessory drive belt(s)	Horn operation
Battery performance	Radiator, cooler, heater and A/C hoses
Engine air filter	Suspension component for leaks or damage
Exhaust system	Steering and linkage
Exterior lamps and hazard warning system operation	Tires (including spare) for wear and proper pressure**
Fluid levels*; fill if necessary	Windshield for cracks, chips or pits
For oil and fluid leaks	Washer spray and wiper operation

\* Brake, coolant recovery reservoir, automatic transmission, power steering and window washer.

\*\*If your vehicle is equipped with a temporary mobility kit, check the tire sealant expiration Use By date on the canister. Replace as needed.

# Scheduled Maintenance

Be sure to ask your dealership service advisor or technician about the multi-point vehicle inspection. It is a comprehensive way to perform a thorough inspection of

your vehicle. Your checklist gives you immediate feedback on the overall condition of your vehicle.

## NORMAL SCHEDULED MAINTENANCE

<b>Every 7500 miles (12000 km) or six months (whichever comes first)</b>
Change engine oil and filter.
Rotate tires*, inspect tire wear and measure tread depth.
Inspect wheels and related components for abnormal noise, wear, looseness or drag.
Perform multi-point inspection (recommended).

\* Vehicles with dual rear wheels should rotate the front wheels when specified; rear wheels only if unusual wear is noted.

<b>Every 15000 miles (24000 km) or 12 months (whichever comes first)</b>
Inspect automatic transmission fluid level. Consult dealer for requirements.
Inspect brake pads, shoes, rotors, drums, brake linings, hoses and parking brake.
Inspect engine cooling system strength and hoses.
Inspect exhaust system and heat shields.
Inspect steering linkage, ball joints, suspension, tie-rod ends, driveshaft and U-joints. Lubricate if equipped with grease fittings.

<b>Other maintenance items</b>	
Every 30000 miles (48000 km)	Replace engine air filter.
Every 60000 miles (96000 km)	Change automatic transmission fluid and filter. Consult dealer for requirements.
	Replace front wheel bearing grease and grease seal if non-sealed bearings are used.
Every 97500 miles (156000 km)	Replace spark plugs.

## Scheduled Maintenance

---

<b>Other maintenance items</b>	
Every 105000 miles (168000 km)	Change engine coolant.*
	Replace rear axle fluid.
	Inspect accessory drive belt(s).**
Every 150000 miles (240000 km)	Replace accessory drive belt(s) if not replaced within the last 100000 miles (160000 km).
	Replace front wheel bearings and seals if non-sealed bearings are used.
Every two years	Replace brake fluid.

\* Initial replacement at six years or 105000 miles (168000 kilometers), then every three years or 45000 miles (72000 kilometers).

\*\* If not replaced, inspect every 15000 miles (24000 kilometers).



## Scheduled Maintenance

### SPECIAL OPERATING CONDITIONS SCHEDULED MAINTENANCE

If you operate your vehicle **primarily** in any of the following conditions, you need to

perform extra maintenance as indicated. If you operate your vehicle **occasionally** under any of these conditions, it is not necessary to perform the extra maintenance. For specific recommendations, see your dealership service advisor or technician.

<b>Towing a trailer or using a car-top carrier</b>	
Inspect frequently, service as required	Inspect and lubricate U-joints.
	See axle maintenance items under <b>Exceptions</b> .
Every 5000 miles (8000 km)	Inspect the wheels and related components for abnormal noise, wear, looseness or drag.
	Rotate tires*, inspect tires for wear and measure tread depth.
Every 5000 miles (8000 km) or six months	Change engine oil and filter.
	Inspect and lubricate U-joints.
Every 30000 miles (48000 km)	Replace front wheel bearing grease and grease seals if non-sealed bearings are used.

\*Vehicles equipped with dual rear wheels should rotate the front wheels when specified; rear wheels only if unusual wear is noted.

<b>Extensive idling or low-speed driving for long distances, as in heavy commercial use (such as delivery, taxi, patrol car or livery)</b>	
Every 5000 miles (8000 km)	Inspect brake system.
	Inspect wheels and related components for abnormal noise, wear, looseness or drag.
	Lubricate control arm and steering ball joints if equipped with grease fittings.
	Rotate tires*, inspect tires for wear and measure tread depth.
Every 5000 miles (8000 km) or six months	Change engine oil and filter.
	Inspect and lubricate U-joints.

# Scheduled Maintenance

<b>Extensive idling or low-speed driving for long distances, as in heavy commercial use (such as delivery, taxi, patrol car or livery)</b>	
Every 30000 miles (48000 km)	Replace front wheel bearing grease and grease seals if non-sealed bearings are used.
Every 60000 miles (96000 km)	Replace spark plugs.

\*Vehicles equipped with dual rear wheels should rotate the front wheels when specified; rear wheels only if unusual wear is noted.

<b>Operating in dusty or sandy conditions (such as unpaved or dusty roads)</b>	
Inspect frequently, service as required	Replace engine air filter.
Every 5000 miles (8000 km)	Inspect the wheels and related components for abnormal noise, wear, looseness or drag.
	Rotate tires*, inspect tires for wear and measure tread depth.
Every 5000 miles (8000 km) or six months	Change engine oil and filter.
	Inspect and lubricate U-joints.
Every 30000 miles (48000 km)	Replace front wheel bearing grease and grease seals if non-sealed bearings are used.
Every 50000 miles (80000 km)	Change rear axle fluid.

\*Vehicles equipped with dual rear wheels should rotate the front wheels when specified; rear wheels only if unusual wear is noted.

## Exceptions

There are several exceptions to the Normal Schedule:

**Normal vehicle axle maintenance:** Rear axles and power take-off units with synthetic fluid and light-duty trucks equipped with Ford-design axles are lubricated for life; do not check or change fluid unless a leak is suspected, service is required or the assembly has been submerged in water. During long periods

of trailer towing with outside temperatures above 70°F (21°C) and at wide-open throttle for long periods above 45 mph (72 km/h), change non-synthetic rear axle fluid every 3000 miles (4800 kilometers) or three months, whichever comes first. This interval can be waived if the axle is filled with 75W140 synthetic gear fluid meeting

# Scheduled Maintenance

Ford specification WSL-M2C192-A, part number FITZ-19580-B, or equivalent. Add friction modifier XL-3 (EST-M2C118-A) or equivalent for complete refill of Traction-Lok rear axles. See **Capacities and Specifications** (page 111).

**California fuel filter replacement:** If you register your vehicle in California, the California Air Resources Board has determined that the failure to perform this maintenance item does not nullify the emission warranty or limit recall liability before the completion of your vehicle's useful life. Ford Motor Company, however, urges you to have all recommended maintenance services performed at the specified intervals and to record all vehicle service.

**Hot climate oil change intervals:**

Vehicles operating in the Middle East, North Africa, Sub-Saharan Africa or locations with similar climates using an American Petroleum Institute (API) Certified for Gasoline Engines (Certification mark) oil of SM or SN quality, the normal oil change interval is 5000 miles (8000 kilometers).

If the available API SM or SN oils are not available, then the oil change interval is 3000 miles (4800 kilometers).

**Engine air filter replacement:** The life of the engine air filter is dependent on exposure to dusty and dirty conditions. Vehicles operated in these conditions require frequent inspection and replacement of the engine air filter.

## SCHEDULED MAINTENANCE RECORD

<input type="radio"/> Repair Order #:	<p>Dealer stamp</p>
<input type="radio"/> Distance:	
<input type="radio"/> Engine hours (optional):	
<input type="radio"/> Multi-point inspection (recommended): <input type="checkbox"/>	
<input type="radio"/> Signature:	

# Scheduled Maintenance

<input type="radio"/> Repair Order #:	<p>Dealer stamp</p>
<input type="radio"/> Distance:	
<input type="radio"/> Engine hours (optional):	
<input type="radio"/> Multi-point inspection (recommended): <input type="checkbox"/>	
<input type="radio"/> Signature:	

<input type="radio"/> Repair Order #:	<p>Dealer stamp</p>
<input type="radio"/> Distance:	
<input type="radio"/> Engine hours (optional):	
<input type="radio"/> Multi-point inspection (recommended): <input type="checkbox"/>	
<input type="radio"/> Signature:	

<input type="radio"/> Repair Order #:	<p>Dealer stamp</p>
<input type="radio"/> Distance:	
<input type="radio"/> Engine hours (optional):	
<input type="radio"/> Multi-point inspection (recommended): <input type="checkbox"/>	
<input type="radio"/> Signature:	

# Scheduled Maintenance

<input type="radio"/> Repair Order #:	<p>Dealer stamp</p>
<input type="radio"/> Distance:	
<input type="radio"/> Engine hours (optional):	
<input type="radio"/> Multi-point inspection (recommended): <input type="checkbox"/>	
<input type="radio"/> Signature:	

<input type="radio"/> Repair Order #:	<p>Dealer stamp</p>
<input type="radio"/> Distance:	
<input type="radio"/> Engine hours (optional):	
<input type="radio"/> Multi-point inspection (recommended): <input type="checkbox"/>	
<input type="radio"/> Signature:	

<input type="radio"/> Repair Order #:	<p>Dealer stamp</p>
<input type="radio"/> Distance:	
<input type="radio"/> Engine hours (optional):	
<input type="radio"/> Multi-point inspection (recommended): <input type="checkbox"/>	
<input type="radio"/> Signature:	

# Scheduled Maintenance

<input type="radio"/> Repair Order #:	<p>Dealer stamp</p>
<input type="radio"/> Distance:	
<input type="radio"/> Engine hours (optional):	
<input type="radio"/> Multi-point inspection (recommended): <input type="checkbox"/>	
<input type="radio"/> Signature:	

<input type="radio"/> Repair Order #:	<p>Dealer stamp</p>
<input type="radio"/> Distance:	
<input type="radio"/> Engine hours (optional):	
<input type="radio"/> Multi-point inspection (recommended): <input type="checkbox"/>	
<input type="radio"/> Signature:	

<input type="radio"/> Repair Order #:	<p>Dealer stamp</p>
<input type="radio"/> Distance:	
<input type="radio"/> Engine hours (optional):	
<input type="radio"/> Multi-point inspection (recommended): <input type="checkbox"/>	
<input type="radio"/> Signature:	

# Scheduled Maintenance

<input type="radio"/> Repair Order #:	<p>Dealer stamp</p>
<input type="radio"/> Distance:	
<input type="radio"/> Engine hours (optional):	
<input type="radio"/> Multi-point inspection (recommended): <input type="checkbox"/>	
<input type="radio"/> Signature:	

<input type="radio"/> Repair Order #:	<p>Dealer stamp</p>
<input type="radio"/> Distance:	
<input type="radio"/> Engine hours (optional):	
<input type="radio"/> Multi-point inspection (recommended): <input type="checkbox"/>	
<input type="radio"/> Signature:	

<input type="radio"/> Repair Order #:	<p>Dealer stamp</p>
<input type="radio"/> Distance:	
<input type="radio"/> Engine hours (optional):	
<input type="radio"/> Multi-point inspection (recommended): <input type="checkbox"/>	
<input type="radio"/> Signature:	

# Scheduled Maintenance

<input type="radio"/> Repair Order #:	<p>Dealer stamp</p>
<input type="radio"/> Distance:	
<input type="radio"/> Engine hours (optional):	
<input type="radio"/> Multi-point inspection (recommended): <input type="checkbox"/>	
<input type="radio"/> Signature:	

<input type="radio"/> Repair Order #:	<p>Dealer stamp</p>
<input type="radio"/> Distance:	
<input type="radio"/> Engine hours (optional):	
<input type="radio"/> Multi-point inspection (recommended): <input type="checkbox"/>	
<input type="radio"/> Signature:	

<input type="radio"/> Repair Order #:	<p>Dealer stamp</p>
<input type="radio"/> Distance:	
<input type="radio"/> Engine hours (optional):	
<input type="radio"/> Multi-point inspection (recommended): <input type="checkbox"/>	
<input type="radio"/> Signature:	



# Scheduled Maintenance

<input type="radio"/> Repair Order #:	<p>Dealer stamp</p>
<input type="radio"/> Distance:	
<input type="radio"/> Engine hours (optional):	
<input type="radio"/> Multi-point inspection (recommended): <input type="checkbox"/>	
<input type="radio"/> Signature:	

<input type="radio"/> Repair Order #:	<p>Dealer stamp</p>
<input type="radio"/> Distance:	
<input type="radio"/> Engine hours (optional):	
<input type="radio"/> Multi-point inspection (recommended): <input type="checkbox"/>	
<input type="radio"/> Signature:	

<input type="radio"/> Repair Order #:	<p>Dealer stamp</p>
<input type="radio"/> Distance:	
<input type="radio"/> Engine hours (optional):	
<input type="radio"/> Multi-point inspection (recommended): <input type="checkbox"/>	
<input type="radio"/> Signature:	

# Scheduled Maintenance

---

<input type="radio"/> Repair Order #:	<p>Dealer stamp</p>
<input type="radio"/> Distance:	
<input type="radio"/> Engine hours (optional):	
<input type="radio"/> Multi-point inspection (recommended): <input type="checkbox"/>	
<input type="radio"/> Signature:	



# Index

## A

About This Manual.....	3
Protecting the Environment.....	3
ABS	
See: Brakes.....	33
ABS driving hints	
See: Hints on Driving With Anti-Lock	
Brakes.....	33
Accessories	
See: Replacement Parts	
Recommendation.....	6
Adjusting the Steering Wheel.....	8
Audible Warnings and Indicators.....	15
Fail-Safe Cooling Warning Chime.....	15
Headlamps On Warning Chime.....	15
Key in Ignition Warning Chime.....	15
Parking Brake On Warning Chime.....	15
Automatic Transmission.....	29
Brake-Shift Interlock.....	31
If Your Vehicle Gets Stuck In Mud or	
Snow.....	32
Understanding the Positions of Your	
Automatic Transmission.....	29
Automatic Transmission Fluid	
Check.....	79
Adjusting automatic transmission fluid	
levels.....	80
Automatic transmission fluid filter.....	80
Correct fluid level.....	79
High fluid level.....	80
Low fluid level.....	79

## B

Brake Fluid Check.....	80
Hydroboost.....	81
Hydromax.....	81
Parking brake fluid.....	82
Brakes.....	33
General Information.....	33
Breaking-In.....	48

## C

California Proposition 65.....	5
Capacities and Specifications.....	111
Technical Specifications.....	115

Car Wash	
See: Cleaning the Exterior.....	87
Changing a Fuse.....	71
Fuses.....	71
Changing a Road Wheel.....	107
Dissimilar Spare Wheel and Tire Assembly	
Information.....	107
Tire Change Procedure.....	108
Changing the 12V Battery.....	83
Battery relearn.....	84
Changing the Engine Air Filter.....	85
Cleaning the Alloy Wheels.....	88
Cleaning the Engine.....	87
Cleaning the Exterior.....	87
Cleaning Plastic Exterior Parts.....	87
Exterior Chrome.....	87
Stripes or Graphics (if equipped).....	87
Underbody.....	87
Coolant Check	
See: Engine Coolant Check.....	76
Cruise Control.....	8
Principle of Operation.....	35
Cruise control	
See: Using Cruise Control.....	35
Customer Assistance.....	54

## D

Daytime Running Lamps.....	11
Direction Indicators.....	11
Driving Hints.....	48
Driving Through Water.....	49
DRL	
See: Daytime Running Lamps.....	11

## E

Economical Driving.....	48
Emission Control System.....	26
On-Board Diagnostics (OBD-II).....	27
Readiness for Inspection/Maintenance	
(I/M) Testing.....	27
Engine Coolant Check.....	76
Adding Engine Coolant.....	76
Recycled Engine Coolant.....	77
Severe Climates.....	77
What you Should Know About Fail-Safe	
Cooling.....	78

# Index

Engine Oil Check.....	75	General Maintenance Information.....	121
Adding Engine Oil.....	75	Multi-point Inspection.....	123
Resetting the Oil Life Monitoring System.....	75	Owner Checks and Services.....	122
Engine Oil Dipstick.....	75	Protecting Your Investment.....	121
Engine Specifications.....	111	Why Maintain Your Vehicle?.....	121
Drivebelt Routing.....	111	Why Maintain Your Vehicle at Your Dealership?.....	121
Essential Towing Checks.....	44	Getting Assistance Outside the U.S. and Canada.....	57
Before Towing a Trailer.....	45	Getting the Services You Need.....	54
Hitches.....	44	Away From Home.....	54
Launching or Retrieving a Boat or Personal Watercraft (PWC).....	46		
Safety Chains.....	44	<b>H</b>	
Trailer Brakes.....	45	Handbrake	
Trailer Lamps.....	45	See: Parking Brake.....	34
When Towing a Trailer.....	45	Hazard Warning Flashers.....	51
Export Unique Options.....	7	Hints on Driving With Anti-Lock Brakes.....	33
Extended Service Plan (ESP).....	119		
SERVICE PLANS (CANADA ONLY).....	120	<b>I</b>	
SERVICE PLANS (U.S. Only).....	119	Ignition Switch.....	20
		In California (U.S. Only).....	55
<b>F</b>		Information Displays.....	16
Ford Credit.....	5	General Information.....	16
(U.S. Only).....	5	Information Messages.....	17
Fuel and Refueling.....	22	Engine.....	18
Fuel Consumption.....	25	Maintenance.....	18
Calculating Fuel Economy.....	25	Transmission.....	19
Filling the Tank.....	25	Instrument Cluster.....	12
Fuel Filter.....	83	Instrument Lighting Dimmer.....	10
Fuel Quality.....	23	Introduction.....	3
Choosing the Right Fuel.....	23		
Octane Recommendations.....	23	<b>J</b>	
Fuses.....	60	Jump Starting the Vehicle.....	51
Fuse Specification Chart.....	60	Connecting the Jumper Cables.....	52
Diode and Relay Module.....	66	Jump Starting.....	53
Passenger Compartment Fuse Panel.....	67	Preparing Your Vehicle.....	52
Power Distribution Box.....	60	Removing the Jumper Cables.....	53
<b>G</b>		<b>L</b>	
Gauges.....	12	Lighting Control.....	10
Engine Coolant Temperature Gauge.....	13	Headlamp Flasher.....	10
Engine Oil Pressure Gauge.....	12	High Beams.....	10
Fuel Gauge.....	13	Lighting.....	10
Speedometer.....	12		
Transmission Fluid Temperature Gauge.....	12		

# Index

Load Carrying.....	36	Reporting Safety Defects (U.S. Only).....	58
Load Limit.....	36	Roadside Assistance.....	50
Vehicle Loading - with and without a Trailer.....	36	Vehicles Sold in Canada: Getting Roadside Assistance.....	50
Lug Nuts		Vehicles Sold in Canada: Using Roadside Assistance.....	50
See: Changing a Road Wheel.....	107	Vehicles Sold in the United States: Getting Roadside Assistance.....	50
<b>M</b>		Vehicles Sold in the United States: Using Roadside Assistance.....	50
Maintenance.....	72	Roadside Emergencies.....	50
General Information.....	72	Running-In	
Message Center		See: Breaking-In.....	48
See: Information Displays.....	16	Running Out of Fuel.....	23
Mobile Communications Equipment.....	7	<b>S</b>	
Motorcraft Parts.....	112	Safety Precautions.....	22
<b>N</b>		Scheduled Maintenance Record.....	128
Normal Scheduled Maintenance.....	124	Scheduled Maintenance.....	121
<b>O</b>		Snow Chains	
Oil Check		See: Using Snow Chains.....	106
See: Engine Oil Check.....	75	Special Notices.....	6
Ordering Additional Owner's Literature.....	58	New Vehicle Limited Warranty.....	6
Obtaining a French Owner's Manual.....	58	Special Instructions.....	6
<b>P</b>		Special Operating Conditions Scheduled Maintenance.....	126
Parking Brake.....	34	Exceptions.....	127
Perchlorate.....	5	Speed Control	
Power Steering Fluid Check.....	82	See: Cruise Control.....	35
Power linkage lubrication points.....	83	Starter Switch	
<b>R</b>		See: Ignition Switch.....	20
Recommended Towing Weights.....	43	Starting a Gasoline Engine.....	20
Refueling.....	24	Failure to Start.....	21
Fuel Filler Cap.....	24	Guarding Against Exhaust Fumes.....	21
Replacement Parts		Important Ventilating Information.....	21
Recommendation.....	6	Stopping the Engine When Your Vehicle is Moving.....	21
Collision Repairs.....	6	Stopping the Engine When Your Vehicle is Stationary.....	21
Scheduled Maintenance and Mechanical Repairs.....	6	Starting and Stopping the Engine.....	20
Warranty on Replacement Parts.....	6	General Information.....	20
Reporting Safety Defects (Canada Only).....	59	Steering Wheel.....	8
		Symbols Glossary.....	3

# Index

## T

Technical Specifications	
See: Capacities and Specifications.....	111
The Better Business Bureau (BBB) Auto Line Program (U.S. Only).....	56
Tire Care.....	91
Glossary of Tire Terminology.....	92
Information About Uniform Tire Quality Grading.....	91
Information Contained on the Tire	
Sidewall.....	93
Temperature A B C.....	92
Traction AA A B C.....	91
Treadwear.....	91
Tires	
See: Wheels and Tires.....	91
Towing a Trailer.....	42
Load Placement.....	42
Towing the Vehicle on Four Wheels.....	47
Emergency Towing.....	47
Towing.....	42
Transmission Code Designation.....	114
Transmission.....	29
Transmission.....	29
Transporting the Vehicle.....	46

## U

Under Hood Overview.....	73
Commercial chassis.....	74
Motorhome chassis.....	73
Using Cruise Control.....	35
Switching Cruise Control Off.....	35
Switching Cruise Control On.....	35
Using Snow Chains.....	106
Utilizing the Mediation/Arbitration Program (Canada Only).....	56

## V

Vehicle Care.....	87
General Information.....	87
Vehicle Certification Label.....	113
Vehicle Identification Number.....	113

Vehicle Storage.....	88
Battery.....	89
Body.....	89
Brakes.....	89
Cooling system.....	89
Engine.....	89
Fuel system.....	89
General.....	88
Miscellaneous.....	89
Removing Vehicle From Storage.....	89
Tires.....	89
VIN	
See: Vehicle Identification Number.....	113

## W

Warning Lamps and Indicators.....	13
Anti-Lock Braking System.....	13
Battery.....	13
Brake Reserve System.....	14
Brake System.....	14
Cruise Control.....	14
Direction Indicator.....	14
Electronic Throttle Control.....	14
Fasten Safety Belt.....	14
High Beam.....	14
Service Engine Soon.....	14
Transmission Tow/Haul.....	15
Washers	
See: Cleaning the Exterior.....	87
See: Wipers and Washers.....	9
Wheel Nuts	
See: Changing a Road Wheel.....	107
Wheels and Tires.....	91
Technical Specifications.....	110
Windshield Washers.....	9
Windshield Wipers.....	9
Wipers and Washers.....	9